

night

P

PRESOTTO

P

PRESOTTO

Night

Introduzione 4 - 7

Introduction

Letti 8 - 155

Beds

Relevé	10
Cali	20
Fez	28
Shelby	36
Zuko	44
Plica	52
Tebe	60
Niobe	68
Delfi	76
Folio	84
Plaid	92
Izy	100
Wing	108
Meeting_up	116
Meeting	124
Aqua	132
Plana	140
Zero	148

Peplo 156 - 165

Peplo System

Complementi Notte 166 - 189

Night Furniture

Sigma	168
Sibari	170
Box	172
Club	174
Elle	176
Globo	178
Ice	180
Inside	182
Jazz	184
Memories	186
Passion	188
I-night system	190
I-night system_InclinART	192
Onyx	194
Wing	196

Accessori 198 - 227

Accessories

Relevé scrittoio / desk	200
Swing console	202
Swing	204
I-night system	206
I-night system_inclinART	208
Console scrittoio / Console desk	210
Relevé panca / bench	212
Diadro panca / bench	214
Cali panca / bench	216
Point	218
Pilar	220
Pouf Quadrato / Square Pouf	222
Mimesi	224
Tuttospecchio	226

P technical 161

Introduzione

Introduction

Innovazione per tradizione

Innovazione per tradizione non è solo un modo di dire, ma un modo di fare che contraddistingue la nostra storia. Molte cose sono cambiate dal 1948, quando l'avventura dell'azienda è iniziata da Brugnera, vicino a Pordenone.

Negli anni abbiamo realizzato complementi d'arredo a elevato contenuto innovativo, puntando su capacità artigianali del territorio e su un approccio progettistico d'avanguardia per offrire al mercato un prodotto "su misura".

Grazie all'esperienza e alle competenze accumulate negli anni, oggi Presotto è un'azienda solida, internazionale e visionaria, attenta alle necessità e ai desideri del cliente internazionale.

Innovation by tradition

"Innovation by tradition" is not just an expression but a practice that marks our history. Many things have changed since 1948, when the company's adventure started in Brugnera, near Pordenone.

Over the years we have created highly innovative furnishing collections, focusing on the typical craftsmanship skills of our territory and on an innovative design approach to offer the market a "tailor made" product.

Thanks to the experience and expertise inherited over the years, today Presotto is a solid, international and visionary company, that takes care of the international client's needs and desires.

Il passato nel cuore, il futuro nella testa

C'è un filo rosso che segna la nostra evoluzione, un pensiero conduttore identificato da una parola chiave: rispetto.

Abbiamo rispetto per la storia dell'azienda, per i consumatori, le consumatrici e il mercato, proponendo stile, creatività e design autenticamente Made in Italy. Rispettiamo chi collabora con noi e il territorio che abitiamo, praticando una strategia di sviluppo sostenibile in grado di elevare gli standard di sicurezza e di salute sui luoghi di lavoro e di operare in un'ottica di tutela ambientale.

Teniamo al nostro passato e puntiamo ad arredare le vostre case di domani.

Tradition in the soul, future in the mind

There is a sort of fil-rouge that joins the key steps of our evolution, a leading idea identified by one word: respect.

We respect the company's history, consumers and the market, offering style, creativity and design authentically Made in Italy. We respect those who work with us and the territory we live in. We pursue a sustainable development strategy able to raise safety and health standards in the workplace and to operate in an environmental protection perspective.

We care about our past and we look forward to furnish the homes of the future.

Letti

Beds



Relevé



Tebe



Meeting-up



Folio



Delfi



Niobe



Plana



Aqua



Wing



Plica



Plaid



Zuko



Izy



Cali



Fez



Shelby



Zero



Meeting

Relevé



In punta di piedi, come in un passo di danza classica. Questa la suggestione da cui nasce Relevé. Letto in legno dall'animo garbato, caratterizzato da forme esili e dinamiche, Relevé si distingue per la cura dei dettagli nel disegno e nella manifattura. Disponibile in tre finiture essenza con tacco personalizzabile a contrasto, anche con testiera rivestita in pelle o tecnopelle.

On tip-toe, like the steps of a ballet dancer. That's where the inspiration for Relevé comes from. A wooden bed with a graceful soul, distinguished by slim, dynamic lines, Relevé stands out for the care to detail paid to its design and construction. It comes in three different wood veneers and the inside of the legs can be customised in a contrasting finish. This bed is also available with a leather or Tecnopelle headboard.







Letti / Beds



Relevé

RELEVÉ. Letto in rovere tabacco con testiera rivestita in pelle softy colore 724; interno gamba in laccato opaco grigio nebbia.

PILAR. Pouf rivestito in tessuto St. Moritz colore 159 con piano in rovere tabacco.

I-NIGHT SYSTEM. Composizione formata da panca a terra L.900 e comodino H.192 L.750 in laccato opaco grigio nebbia.

RELEVÉ. Tabacco Oak bed with headboard upholstered in Softy leather col. 727; matt Grigio Nebbia lacquered reverse side of legs.

PILAR. Pouf upholstered in St. Moritz fabric col. 159 with Tabacco Oak top.

I-NIGHT SYSTEM. An arrangement consisting of a floor-standing bench W.900 and a nightstand H.192 W. 750 in matt Grigio Nebbia lacquer.



RELEVÉ. Letto in noce canaletto.
JAZZ. Comodino a 2 cassetti L. 560 con struttura e frontali in laccato opaco blu abisso;
inserto in noce canaletto.
POUF QUADRATO. Pouf rivestiti in tessuto Egeo colore 36 e pelle Polo colore 930.

RELEVÉ. Bed in Canaletto walnut.
JAZZ. 2-drawer night stand W.560 with structure and fronts in matt Blu Abisso lacquer;
insert in Canaletto walnut.
SQUARE POUF. Pouf upholstered in Egeo fabric col. 36 and Polo leather col. 930.

RELEVÉ. Letto in noce canaletto con testiera rivestita in pelle softy colore 728.
RELEVÉ. Panca con struttura e piano in rovere dark.

RELEVÉ. Bed in Canaletto walnut with headboard upholstered in Softy leather col. 728.
RELEVÉ. Bench with a Dark Oak structure and top.



Cali



Cali è un letto anticonformista composto da elementi in contrasto tra loro. Un ring appena accennato disegna un sottile profilo attorno al letto mentre la testiera è risolta da due abbondanti e morbidi cuscini adagiati su un elemento di sostegno. Il ring si appoggia a terra su sottili piedini in metallo, offrendo una suggestione di assoluta leggerezza.

Cali is an unconventional bed made up of contrasting elements. An inconspicuous bed frame draws a slim line around the bed and the headboard consists of two large, soft cushions laying on a support. The bed frame stands on slim, metal feet, giving a feeling of total lightness.







CALI. Letto monocolore con struttura e cuscini rivestiti in pelle Softy colore 727, piedini cilindrici in laccato metallico brunito.
 ONYX. Comodino a 2 cassetti L.753 con struttura e frontali in laccato lucido bianco latte, maniglia Lipsi in finitura brunita.
 EQUIS. Tavolino con basamento in laccato metallico brunito e piano ovale in marmo satinato bianco carrara.
 CALI. Panca imbottita con rivestimento in pelle Softy colore 727, piedini cilindrici in laccato metallico brunito.
 TOWER. Libreria finitura grigio antracite su metallo con basamento in marmo bianco carrara.

CALI. Single-coloured bed with a structure and cushions upholstered in Softy leather col. 727. Featuring cylindrical feet in Burnish metallic lacquer.
 ONYX. 2-drawer night stand W.753 with structure and fronts in gloss Bianco Latte lacquer; burnished metallic Lipsi handles.
 EQUIS. Coffee table with a Burnish metallic lacquer base and Bianco Carrara satin marble oval top.
 CALI. Padded bench upholstered in Softy leather col. 727, featuring cylindrical feet in Burnish metallic lacquer.
 TOWER. Metal bookcase with a Grigio Antracite finish and a Bianco Carrara marble base.



CALI. Letto bicolore con struttura rivestita in pelle Nuvola colore 199 canapa e cuscini in tessuto Indio colore 89, piedini cilindrici in laccato metallico Brass.
CLUB. Comodino a 2 cassetti L.553 con struttura e frontali in laccato opaco grigio polvere.
I-NIGHT SYSTEM. Base a terra L.2400 H. 192 in rovere avana.

CALI. Dual-coloured bed with a structure upholstered in Nuvola leather col. 199 canapa and cushions in Indio fabric col. 89. Brass metallic lacquer cylindrical feet.
CLUB. 2-drawer night stand W.553 with structure and fronts in matt Grigio Polvere lacquer.
I-NIGHT SYSTEM. A floor-standing base unit W.2400 H.192 in Avana Oak.



Fez



Come l'omonima città si adagia su morbide colline, così Fez ci parla di comodità. La testata imbottita reclinata è pensata per dare un elevato livello di confort, rendendo il letto piacevole anche nei momenti di lettura. Il letto viene proposto con giroletto essenziale sostenuto da piedini metallici.

Like the city name, the Fez bed expresses comfort. The reclining, padded headboard has been designed to deliver high comfort that make this bed also perfect for reading. It comes with a minimal frame supported by metal feet.







Letti / Beds



FEZ. Letto rivestito in tessuto Egeo colore 48, piedini cilindrici in laccato metallico brunito.
SIBARI. Comodino a 2 cassetti L.553 con struttura, frontali e cornice in laccato opaco grigio nebbia, top in rovere avana.
I-NIGHT SYSTEM. Panca sospesa L.2400 in rovere avana.
TECNOPOLIS ANTA LISCIA. Armadio battente con anta in rovere avana e maniglia Lipsi in laccato metallico brunito.

FEZ. Bed upholstered in Egeo fabric col. 48 featuring cylindrical feet in Burnish metallic lacquer.
SIBARI. 2-drawer night stand W.553 with structure, fronts and frame in matt Grigio Nebbia lacquer and Avana Oak top.
I-NIGHT SYSTEM. A wall-mount bench W.2400 in Avana Oak.
TECNOPOLIS WITH LISCIA DOOR. Wardrobe with Avana Oak swing door and Burnish metallic lacquered Lipsi handle.

Fez

FEZ. Letto rivestito in tessuto Regal colore 001, piedini cilindrici in laccato metallico Brass.
SIGMA. Comodino a 3 cassetti L.553 con struttura e frontali in laccato opaco beige cappuccino, maniglia in laccato metallico Brass.

FEZ. Bed upholstered in Regal fabric col. 001 and featuring cylindrical feet in Brass metallic lacquer.
SIGMA. 3-drawer night stand W.553 with structure and fronts in matt Beige Cappuccino lacquer. Handles in Brass metallic lacquer.



Shelby



Un volume imbottito dalla forma ironica e glamour allo stesso tempo, rivisitato in chiave contemporanea, identifica la preziosa testiera; Shelby è un letto morbido e sinuoso ispirato agli iconici sedili delle automobili anni sessanta. Presenta ring rivestito in tessuto, pelle o tecnopelle, è caratterizzato da una cucitura diagonale in corrispondenza degli angoli ed è sostenuto da piedini metallici a sezione circolare. Disponibile anche con testiera in versione bicolore.

The stylish upholstered headboard makes the bed glamour and ironic at the same time. Shelby is a soft, curvy bed inspired by the iconic seats of 60s' cars. Its bed frame is upholstered in fabric, leather or Tecnopelle featuring diagonal stitching in the corners and it lays on cylindrical, metal feet. This bed is also available with a dual-coloured headboard.







SHELBY. Letto monocolore rivestito in tessuto Egeo colore 08, piedini cilindrici in laccato metallico brunito.
PILAR. Pouf rivestito in tessuto St. Moritz colore 134 con piano in castagno naturale.
I-NIGHT SYSTEM. Base a terra L.1500 H.384 in castagno naturale.
MIMESI. Specchietallico brera a parete con cornice in laccato brunito.
TECNOPOLIS ANTA TELAIO VETRO. Armadio battente con anta telaio in alluminio in finitura grigio Londra e vetro satinato grigio. Struttura e attrezzatura interna in melaminico eucalipto.

SHELBY. Single-coloured bed upholstered in Egeo fabric col. 08 and featuring cylindrical feet in Burnish metallic lacquer.
PILAR. Pouf upholstered in St. Moritz fabric col. 134 with Castagno Naturale top.
I-NIGHT SYSTEM. A floor-standing base unit W.1500 H.384 in Castagno Naturale.
MIMESI. Wall-hung mirror with a Burnish metallic lacquer frame.
TECNOPOLIS WITH FRAMED GLASS DOORS. Swing-door wardrobe with Grigio Londra finished aluminium frames and glazed grey glass. Eucalipto melamine structure and interior accessories.

SHELBY. Letto monocolore rivestito in tecnopelle Dusk colore A398/1, piedini cilindrici in laccato metallico brunito.
BOX. Comodino a 2 cassetti L.551 con struttura e frontali in laccato opaco grigio tasmania.

SHELBY. Single-coloured bed upholstered in Dusk Tecnopelle col. A398/1, featuring cylindrical feet in Burnish metallic lacquer.
BOX. 2-drawer night stand W.551 with structure and fronts in matt Grigio Tasmania lacquer.



Zuko



Morbida e dalla forma importante, la testiera del letto Zuko ammicca a passate atmosfere hollywoodiane, richiamandone classe e raffinatezza. Disponibile anche in versione bicolore, la testiera è elemento strutturale in appoggio a terra. Il letto presenta un ring rivestito in tessuto, pelle o tecnopelle caratterizzato da una cucitura diagonale in corrispondenza degli angoli e sostenuto da piedini metallici a sezione circolare.

With its soft, curvy shape, the headboard of the Zuko bed looks back to the Hollywood-style atmospheres of past days, reflecting their style and refinement. Also available in a dual-coloured version, the headboard is the bed's floor-standing structural element. The bedframe is upholstered in fabric, leather or Tecnopelle featuring diagonal stitching in the corners and it lays on cylindrical, metal feet.







ZUKO. Letto bicolore con testiera e giroletto rivestiti in tecnopelle Aire colore M2390, fianchi e retro della testiera rivestiti in tessuto Dickinson colore 14. Piedini cilindrici in laccato metallico brunito.
GLOBO. Comodino con struttura e frontali in laccato opaco beige seta e piano in marmo satinato bianco carrara.

ZUKO. Dual-coloured bed with headboard and bed frame upholstered in Aire Tecnopelle col. M2390. Featuring cylindrical feet in Burnish metallic lacquer.
GLOBO. Night stand with structure in matt Beige Seta lacquer and a Bianco Carrara satin marble top.



ZUKO. Letto monocolore con testiera e giroletto rivestiti in tecnopelle Sand colore N502. Piedini cilindrici in laccato metallico brunito.
DIADRO. Panca con piano in rovere dark e basamento in laccato opaco rosa litchi.

ZUKO. Single-coloured bed with headboard and bedframe upholstered in Sand Tecnopelle col.N502. Featuring cylindrical feet in Burnish metallic lacquer.
DIADRO. Bench with a Dark Oak top and a matt Rosa Litchi lacquered base.



Plica



Una forma sinuosa culla il tuo sonno. La natura di Plica sta nel suo disegno, caratterizzato da una soffice imbottitura dai bordi stondati. Letto dal design unico, disponibile in due versioni distinte: leggero e delicato se poggiano su piedini; solido e maestoso con sottoringo rientrante nella versione contenitore, il quale può essere rivestito coordinato al letto o in legno plissettato, per un aspetto più distintivo.

Its curvy shape lulls your sleep. Plica's nature is confirmed by the design distinguished by soft padding with rounded edges. It's a bed with a unique line, available in two distinct versions: soft and light when supported by feet; sturdy and majestic in the storage version. The recessed base can be covered matching the bed or in a more distinctive pleat-effect wood.







PLICA. Letto rivestito in tessuto Regal colore 033. Sottoring plissettato in castagno naturale.
MW. Tavolino con basamento in laccato opaco nero frac e piano rotondo ø630 in marmo satinato grigio carnico.
I-NIGHT SYSTEM. Base a terra H.384 L.1800 in laccato lucido beige cappuccino.

PLICA. Bed upholstered in Regal fabric col. 033. Bedframe base in pleat-effect Castagno Naturale.
MW. Coffee table with matt Nero Frac lacquered base and Grigio Carnico satin marble round top ø630.
I-NIGHT SYSTEM. A floor-standing base unit W.1800 H.384 in gloss Beige Cappuccino lacquer.



PLICA. Letto rivestito in tessuto Matala colore 3017. Piedini cilindrici in laccato metallico brunito.
WING. Comodino a 2 cassetti L.553 con struttura e frontali in rovere dark.
SWING CONSOLE. Scrivitoio con struttura laccato opaco beige fango.
PILAR. Pouf rivestito in tessuto Matala colore 3005.

PLICA. Bed upholstered in Matala fabric col. 3017. Featuring cylindrical feet in Burnish metallic lacquer.
WING. 2-drawer night stand W.553 with structure and fronts in Dark Oak.
SWING CONSOLE TABLE. Desk with a matt Beige Fango lacquered structure.
PILAR. Pouf upholstered in Matala fabric col. 3005.



Tebe



Sommier centro stanza in essenza dal sobrio e raffinato appeal. Un volume geometrico la cui personalità è definita dalle abitudini del suo fruitore. Tebe è un letto dallo stile essenziale e versatile, la cui personalità è definita dal mix di finiture: il giroletto presenta un profilo interno a contrasto con l'esterno, mentre le testate imbottite sono regolabili e posizionabili su tutti i lati.

A free-standing, wood veneered sommier with a sober and elegant appeal. A geometric volume whose personality is defined by the habits of its user. The Tebe bed features a minimal and versatile style. The combination of finishes defines its personality: the interior edge of the bed ring contrasts with its exterior while the padded headboards can be adjusted and moved to any side.







TEBE. Letto in noce canaletto con profilo interno in laccato opaco grigio antracite; testiere rivestite in tessuto Chalaïn colore 2.
 TECNOPOLIS ANTA MEG. Armadio battente in laccato opaco grigio calce e profilo maniglia in laccato opaco grigio antracite.
 PILAR. Pouf rivestito in pelle Softy colore 728 con piano in noce canaletto.

TEBE. Bed in Canaletto walnut with a matt Grigio Antracite interior edge; headboards upholstered in Chalaïn fabric col. 2.
 TECNOPOLIS WITH MEG DOORS. Wardrobe with matt Grigio Calce lacquered swing door and matt Grigio Antracite lacquered full-length grip edge.
 PILAR . Pouf upholstered in Softy leather col. 728 with Canaletto walnut top.





TEBE. Letto in rovere avana con profilo interno in laccato opaco rosso vermut; testiere rivestite in pelle Nuvola colore 147 moretto.
 MEMORIES. Comò a 4 cassetti L.1427 con struttura e frontali in rovere avana, basamento metallico in finitura brunita.
 EVIA. Poltroncina con struttura in frassino laccato nero e rivestimento in tessuto Indio colore 89.

TEBE. Avana Oak bed with interior edge in matt Rosso Vermut lacquer. Headboards upholstered in Nuvola leather col. 147 Moretto
 MEMORIES. 4-drawer dresser W.1427 with structure and fronts in Avana Oak and a burnished finish metal base.
 EVIA. Armchair with Nero lacquered ash legs upholstered in Indio fabric col. 89.

Niobe



Apollineo, maestoso, di classe. Niobe, il letto dalla testiera extra-lusso, si presenta come elemento dalle dimensioni importanti ed è indicato per spazi ampi. La testiera è caratterizzata da una serie di pannelli imbottiti in pelle o tessuto che alternando dimensioni e cuciture disegnano diverse personalità. Disponibile in molteplici configurazioni di larghezza e altezza, in versione simmetrica o asimmetrica, Niobe lascia libero spazio all'interpretazione della camera dei sogni.

Beautiful, majestic and stylish. The Niobe bed with its luxurious headboard, is particularly large and suitable for ample spaces. The headboard features a set of padded panels upholstered in leather or fabric. It describes different personalities by alternating their dimensions and stitchings. Available in various widths and heights, either symmetrical or asymmetrical, Niobe gives you total freedom to create the bedroom of your dreams.







NIOBE. Letto con testiera asimmetrica rivestito in pelle Softy colore 727, piedini in laccato metallico brunito.
I-NIGHT SYSTEM inclinART. Composizione formata da base a terra L.900 H.192 inclinata a destra e base in appoggio L.900 H.192 inclinato a sinistra in laccato opaco grigio polvere.

NIOBE. Bed with an asymmetric headboard upholstered in Softy leather col. 727. Featuring cylindrical feet in Burnish metallic lacquer.
I-NIGHT SYSTEM inclinART. An arrangement consisting of a floor-standing base unit W.900 H.192 slanting to the right and a base unit W.900 H.192 slanting to the left sitting on top of it all in matt Grigio Polvere lacquer.

NIOBE. Letto con testiera simmetrica rivestito in tessuto Dickinson colore 7, piedini in laccato metallico Iron.
IRORI. Tavolino con struttura in laccato opaco verde timo con traverso in laccato metallico Iron e top in marmo satinato bianco carrara.

NIOBE. Bed with a symmetric headboard upholstered in Dickinson fabric col. 7. Featuring cylindrical feet in Iron metallic lacquer.
IRORI. Coffee table with matt Verde Timo lacquered frame and Iron metallic lacquer crossbar; Bianco Carrara satin marble top.



Delfi



Una, nessuna, centomila. L'identità di Delfi è determinata dalla sua testiera imbottita: appesa al muro, importante o contenuta, con il giroletto in accosto. Grazie a solidi lacci in pelle che lo fissano a preziosi pomoli in metallo, il letto appare essenziale, contemporaneo, intramontabile.

One, no one, one hundred thousand. Delfi's identity is defined by its upholstered headboard: hung from the wall, large or medium-sized, the bedframe leans against it. The sturdy leather eyelets that attach it to the precious metal knobs give the bed a minimal, contemporary and timeless appeal.







DELFI. Testiera H.950 rivestita in pelle Nuvola colore 141 antracite e pomoli in finitura brunita.
Ring imbottito in tessuto Elissos colore 5.
KONA. Tavolino triangolo H.500 con basamento in laccato opaco nero frac e piano in laccato opaco grigio nebbia.
KONA. Tavolino triangolo H.400 con basamento in laccato opaco nero frac e piano in ceramica calacatta.

DELFI. 950-mm high headboard upholstered in Nuvola leather col. 141 Antracite with burnished finish knobs. Padded bed frame upholstered in Elissos fabric col. 5.
KONA. Triangle coffee table H.500 with matt Nero Frac lacquered frame and matt Grigio Nebbia lacquered top.
KONA. Triangle coffee table H.400 with matt Nero Frac lacquered frame and Calacatta ceramic top.



DELFI. Testiera H.450 rivestita in pelle Polo colore 856 e pomoli in finitura brunita. Ring imbottito in tessuto Dickinson colore 14.

PASSION. Comodino rivestito in pelle vissuta colore Creta 109 e frontali laccato opaco grigio nebbia.

DELFI. 450-mm high headboard upholstered in Polo leather col. 856 with burnished finish knobs. Padded bed frame upholstered in Dickinson fabric col. 14.

PASSION. Night stand covered with "aged" leather Creta 109 and featuring matt Grigio Nebbia lacquered fronts.

Folio



Folio presenta un'ampia gamma di pannelli boiserie in essenza, imbottiti in cuoio o tecnopelle, sapientemente abbinati tra loro, a comporre la sua testiera a parete. Il modello, altamente componibile e versatile, si presenta in diverse misure ed è in grado di integrarsi con comodino e mensole opzionali, in un mix di finiture dalla forte personalità.

Folio features a wide range of wall panels - either wood veneered or upholstered and covered with hide or Tecnopelle - cleverly put together to make its wall-mount headboard. This versatile, model is available in different sizes and can be integrated with optional night stands and shelves in a combination of finishes expressing a really strong personality.







FOLIO. Testiera a muro formata da pannelli laterali L.750 in noce canaletto e centrali rivestiti in cuoio colore avorio. Ring imbottito in pelle Polo 810.
 CLUB. Comodino a 2 cassetti L.753 con struttura e frontali in laccato opaco beige seta.
 MW. Tavolino con basamento in laccato metallico brunito e piano rotondo ø430 in laccato opaco beige fango.
 MW. Tavolino con basamento in laccato metallico brunito e piano rotondo ø630 in marmo satinato bianco carrara.

FOLIO. Wall-mount headboard made up of 750-mm wide panels in Canaletto walnut and Avorio-coloured hide. Padded bed frame upholstered in Polo leather col. 810.
 CLUB. 2-drawer night stand W.753 with structure and fronts in matt Beige Seta lacquer.
 MW. Coffee table with Burnished metallic lacquer base and matt Beige Fango lacquered round top ø430.
 MW. Coffee table with Burnished metallic lacquer base and Bianco Carrara satin marble round top ø630.



FOLIO. Testiera a muro formata da pannelli laterali L.900 in castagno naturale e pannelli centrali L.1800 rivestiti in tecnopelle Dusk colore A398/1. Ring imbottito in tecnopelle Dusk colore A398/1.
I-NIGHT SYSTEM. Comodino sospeso a 1 cassetto L.900 con struttura e frontale in castagno naturale.
TILIA. Sedia con braccioli, struttura in frassino laccato nero, seduta in corda intrecciata colore naturale.

FOLIO. Wall-mount headboard made up of 900-mm wide side panels in Castagno Naturale and 1800-mm wide central panels upholstered in Dusk Tecnopelle col. A398/1. Padded bed frame upholstered in Dusk Tecnopelle col. A398/1.
I-NIGHT SYSTEM. 1-drawer night stand W.900 with structure and front in Castagno Naturale.
TILIA. Chair with armrest with Nero lacquered ash frame and seat in Natural-coloured woven rope.



Plaid



Una coperta delicatamente appoggiata. Un gesto misurato che parla di attenzione. Da qui prendono spunto le linee che caratterizzano il letto Plaid. Una testiera imbottita ricurva che poggia leggera su un elemento di sostegno, affiancata a un giroletto imbottito e rigoroso.

A blanket spread out gracefully on the bed. An attentive gesture that shows consideration. The lines that distinguish the Plaid bed are inspired by this. A curved, upholstered headboard lays lightly on a support, flanked by a padded, square bed frame.







PLAID. Letto con testiera H.920 rivestito in tessuto Indio colore 96.
CLUB. Comodino a 2 cassetti L.553 con struttura e frontali in rovere avana.
I-NIGHT SYSTEM. Base sospesa L.1800 in laccato lucido beige seta.
TECNOPOLIS ANTA NAOS. Armadio battente con anta in pelle Nuvola colore 179 lino, profili e maniglia in laccato metallico brunito.

PLAID. Bed with a 920-mm high headboard upholstered in Indio fabric col. 96.
CLUB. 2-drawer night stand W.553 with structure and fronts in Avana Oak.
I-NIGHT SYSTEM. A wall-hung base unit W.1800 H.384 in gloss Beige Seta lacquer.
TECNOPOLIS WITH NAOS DOORS. Swing door wardrobe with Nuvola leather col. 179 lino, burnished metallic lacquered profiles and handles.



PLAID. Letto con testiera H.920 rivestito in tessuto Elissos colore 15.
ELLE. Comodino a 2 cassetti L.593 con struttura e frontali in laccato opaco grigio polvere.
CALI. Panca imbottita con rivestimento in pelle vissuta colore Creta 109, piedini cilindrici in laccato metallico Iron.

PLAID. Bed with a 920-mm high headboard upholstered in Elissos fabric col.15.
ELLE. 2-drawer night stand W.593 with structure and fronts in matt Grigio Polvere lacquer.
CALI. Padded bench upholstered in "aged" leather Creta 109. Featuring cylindrical feet in Iron metallic lacquer.



Una sottile ala laterale, geometrica e dalla linea pulita chiude leggermente verso il corpo del letto; questo vezzo, in grado di parlare di intimità e carattere, distingue il letto Izy. La testiera, decorata da una raffinata trapuntatura verticale, può essere unica, con pannello laterale singolo o doppio. Un letto solido e ben strutturato, con ring contenitore in appoggio a terra o sostenuto da piedini.

The Izy bed gives a feeling of intimacy and character through its slim side wings and geometric lines folding gently inwards. The headboard, decorated with refined vertical stitching, can be single or with one or two side panels. A sturdy, well-structured bed with a floor-standing storage base or supported by feet.







IZY. Letto con doppio pannello laterale alla testiera e ring H.73 mm rivestito in tecnopelle Dusk colore 492. Piedini cilindrici in laccato metallico brunito.
 ONYX. Comodino a 2 cassetti L.553 con struttura e frontali in laccato opaco beige argilla, maniglia Kono in finitura brunita.
 PEPLO. Composizione monofacciale in laccato opaco bianco latte con pomoli appendiabiti in finitura brunita. L.2614 H.1600 P.580.

IZY. Bed with two side panels on the headboard and a 73-mm high bedframe upholstered in Dusk Tecnopelle col. 492. Featuring cylindrical feet in Burnished metallic lacquer.
 ONYX. 2-drawer night stand W.553 with structure and fronts in matt Beige Argilla lacquer; burnished metallic Kono handles.
 PEPLO. A single-faced layout in matt Bianco Latte lacquer containing a drawer unit and featuring Burnished finish round hooks. W.2614 H.1600 D.580.



IZY. Letto con testiera e ring contenitore H.289 mm rivestito in tessuto MATALA colore E3005
ELLE. Comodino a 2 cassetti L.593 con struttura e frontali in castagno naturale.
EVIA. Poltroncina con struttura in frassino naturale e rivestimento in tessuto Indio colore 93.

IZY. Bed with headboard and H.289 mm storage base upholstered in E3005-coloured Matala fabric.
ELLE. 2-drawer night stand W.593 with structure and fronts in Castagno Naturale.
EVIA. Armchair with Natural ash legs upholstered in Indio fabric col. 93.



Wing



Un letto dalla forte personalità, connubio perfetto tra equilibrio dei volumi e compattezza delle forme. Wing, come suggerisce il suo nome, si mostra leggero grazie a una vasta gamma di testiere sospese da fissare a muro, diverse per disegno e dimensione, impreziosite da un cordino in contrasto. La rete a doghe delimitata da una cornice perimetrale imbottita, è sostenuta da un piede in metacrilato, che conferisce leggerezza a tutta la struttura. Opzionale l'illuminazione a led. Il letto è disponibile anche con ring a terra e in versione contenitore.

A bed with a strong personality, a perfect combination of balanced volumes and compact forms. As its name suggests, Wing has a light design and a wide range of wall-mount headboards available in different dimensions and decorated with contrasting-coloured cord trim. The slatted base with its padded frame and based on a methacrylate support that gives a lightweight appearance to the whole structure. Optional led lighting. The bed is also available in the storage version or with a floor-level bed frame.







WING. Letto con testiera Capitonè e cornice perimetrale rivestita in pelle Nuvola colore 179 lino; basamento in metacrilato.

WING. Comodino sospeso ad un cassetto con struttura e frontale in rovere tabacco.

GLOBO. Comodino con struttura e frontali in laccato lucido beige seta e piano in marmo lucido bianco carrara.

I-NIGHT SYSTEM. Comò a 4 cassetti L.1200 con struttura e frontali in rovere tabacco.

WING. Bed with a Capitonè headboard and a frame upholstered in Nuvola leather col. 179 lino. The support is in methacrylate.

WING. Wall-hung night stand with one drawer with structure and front in Tabacco Oak.

GLOBO. Night stand with structure in gloss Beige Seta lacquer and a Bianco Carrara polished marble top.

I-NIGHT SYSTEM. 4-drawer dresser W.1200 with structure and fronts in Tabacco Oak.



WING. Letto con testiera Liscia e ring imbottito a in tessuto Elissos colore 15.
SIBARI. Comodino a 2 cassetti L.553 con struttura e frontali in laccato opaco arancio cotto, cornice laccato opaco nero frac, top in specchio bronzo.
MW. Tavolino con basamento in laccato metallico brunito e piano rotondo ø430 in marmo satinato grigio carnico.
MW. Tavolino con basamento in laccato metallico brunito e piano rotondo ø630 in laccato opaco grigio antracite.

WING. Bed with a Liscia headboard and a frame upholstered in Elissos fabric col. 15.
SIBARI. 2-drawer night stand W.553 with structure and fronts in matt Arancio Cotto lacquer, frame in matt Nero Frac lacquer and Bronzo mirror top.
MW. Coffee table with Burnished metallic lacquer base and Grigio Carnico satin marble round top ø430.
MW. Coffee table with Burnished metallic lacquer base and matt Grigio Antracite lacquered round top ø630

Meeting_up



Meeting_Up è un letto imbottito con ring a terra ed eventuale contenitore. La testiera è l'elemento distintivo, decostruita in due forme trapezoidali adagiate una sull'altra. La struttura sfoderabile può essere bicolore o monocromatica. Il ring in versione bicolore di forma trapezoidale svasata dialoga con la testiera.

Meeting_Up is an upholstered bed with a floor-level bedframe also available with a storage base. The headboard, made up of two overlapping trapezoidal parts, is the distinctive character of this bed. The removable cover can be in one or two colours. The dual-coloured bed frame with its trapezoidal, flaring shape matches with the headboard.

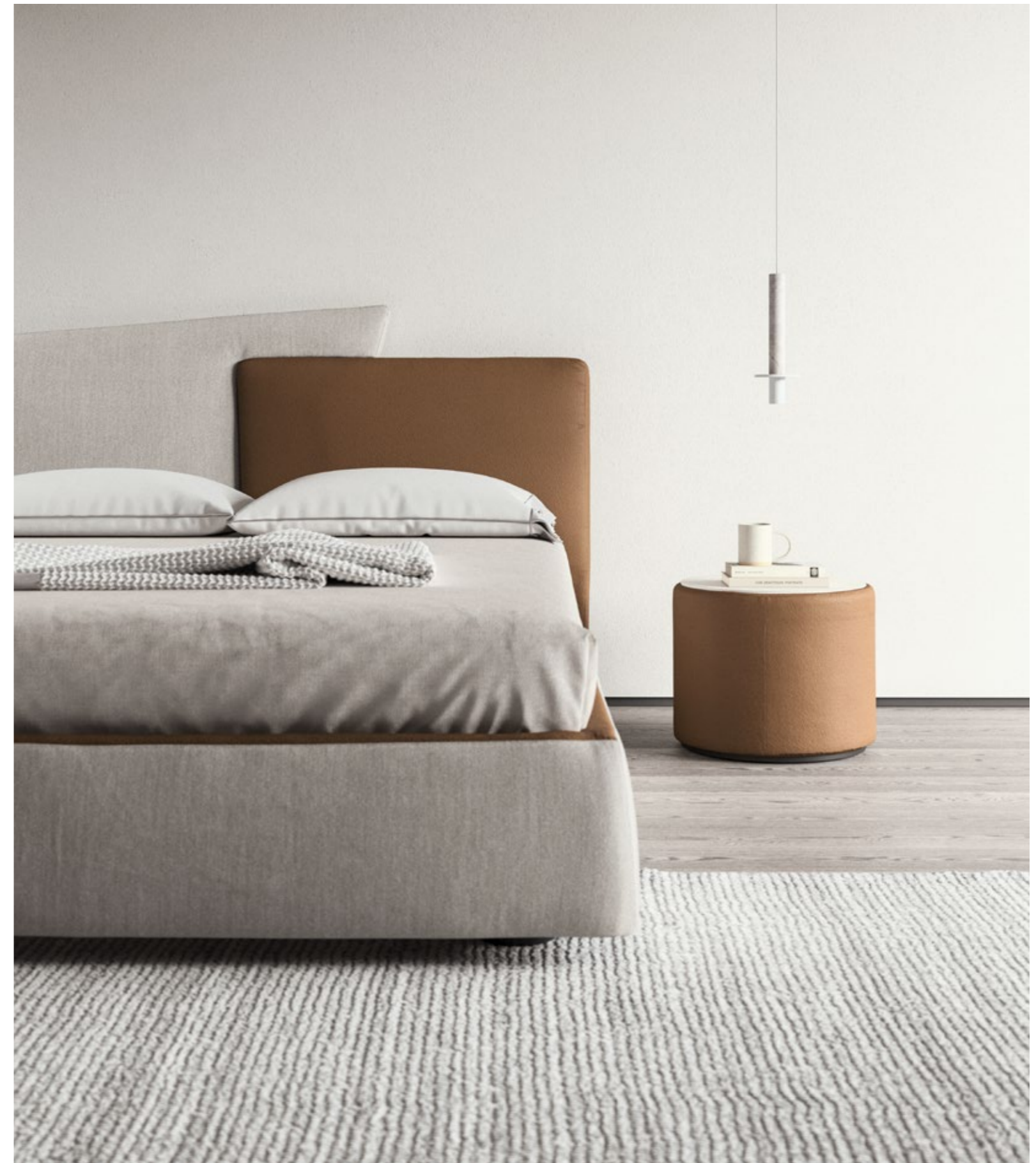





P 116-121
MEETING_UP. Letto bicolore rivestito in tessuto Egeo colore 3 e tecnopelle Dusk colore M848.
PILAR. Pouf rivestito in tecnopelle Dusk colore M848 con piano in laccato opaco beige seta.
TUTTOSPECCHIO. Specchiera a terra con piedini cromati.

MEETING_UP. Letto monocolore rivestito in tessuto St. Moritz colore 041.
RELEVÉ. Panca con struttura e piano in rovere dark.

P 116-121
MEETING_UP. Dual-coloured bed upholstered in Egeo fabric col. 3 and Dusk Tecnopelle col. M848.
PILAR. Pouf upholstered in Dusk Tecnopelle col. M848 with matt Biege Seta lacquered top.
TUTTOSPECCHIO. Floor-standing mirror with chromed feet.

MEETING_UP. Single-coloured bed upholstered in St. Moritz fabric col. 041.
RELEVÉ. Bench with a Dark Oak structure and top.



Meeting



Meeting è un letto imbottito dal disegno originale e dinamico. L'elemento distintivo è la testiera, decostruita in due forme trapezoidali disponibili in versione monocoloro o bicolore. Diverse le scelte per il sostegno del giroletto imbottito: a slitta, con piedini in metallo oppure con lastra in metacrilato trasparente dotata di illuminazione led optional.

Meeting is a upholstered bed with an original, dynamic design. Its distinctive trait is its headboard made up of two, separate trapezoidal shapes available in the single or dual-coloured version. Various types of leg supports are available: a sledge base, metal feet or a transparent methacrylate panel with optional led lighting.

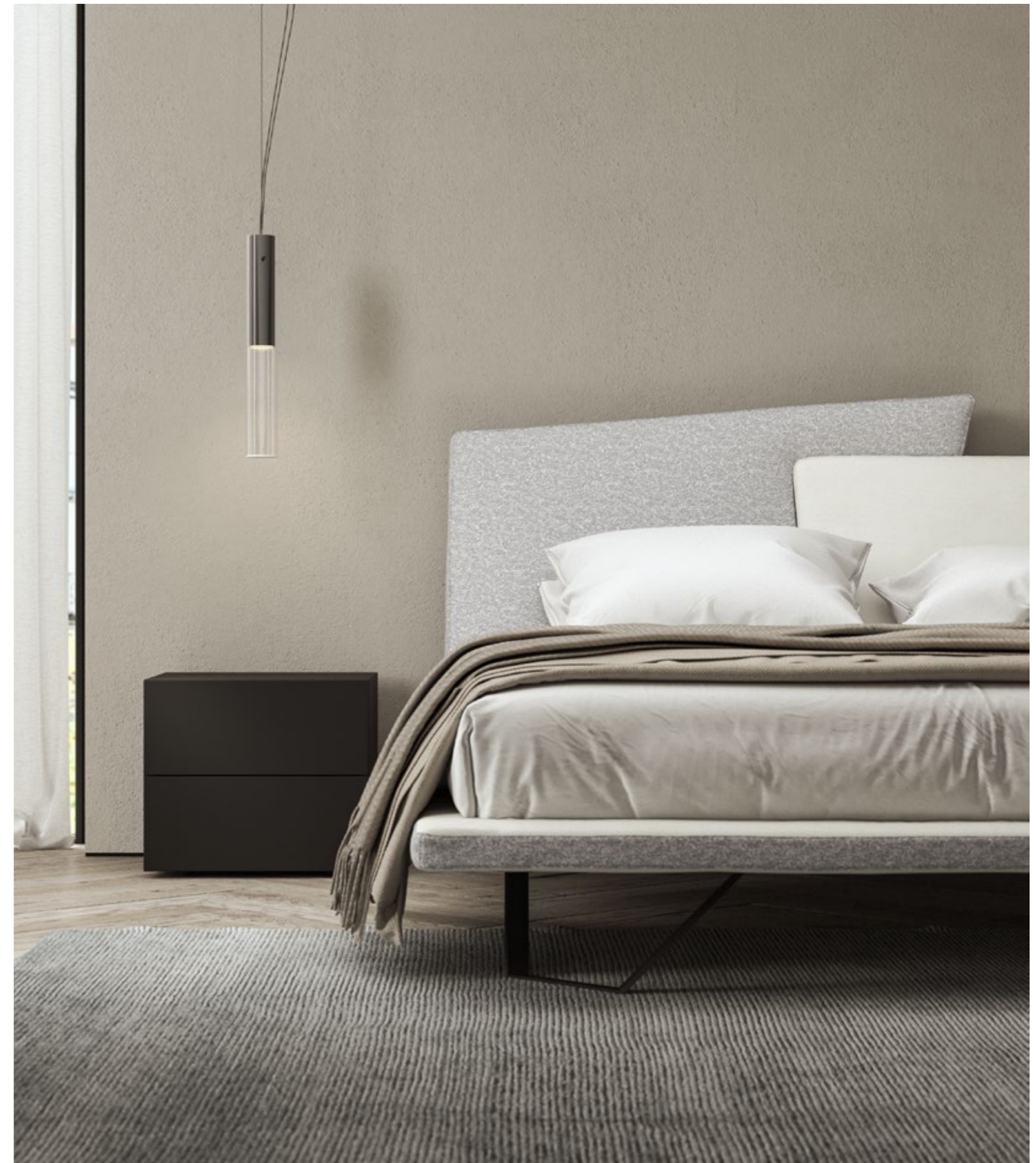





MEETING. Letto bicolore rivestito in tessuto Ubye colore 1 e tessuto Egeo colore 01; basamento a slitta in laccato opaco nero frac.

I-NIGHT SYSTEM. Comodino a 2 cassetti L.450 con struttura e frontali in laccato opaco nero frac.

MW. Tavolino con basamento e piano rotondo ø430 in laccato opaco nero frac.

MW. Tavolino con basamento in laccato metallico brunito e piano rotondo ø630 in marmo satinato bianco carrara.

DIADRO. Panca con piano in laccato opaco nero frac e basamento in laccato metallico brunito.

MEETING. Dual-coloured bed upholstered in Ubye fabric col. 1 and Egeo fabric col. 01.

I-NIGHT SYSTEM. 2-drawer night stand W.450 with structure and fronts in matt Nero Frac lacquer.

MW. Coffee table with matt Nero Frac lacquered round top ø430 and base.

MW. Coffee table with Burnished metallic lacquer base and Bianco Carrara satin marble round top ø630.

DIADRO. Bench with a matt Nero Frac lacquered top and a Burnish metallic lacquered base.



MEETING. Letto monocolore rivestito in tessuto tessuto Egeo colore 28; piedini cilindrici in laccato opaco arancio cotto.
ELLE. Comodino a 2 cassetti L.793 con struttura e frontali in laccato lucido rosa pompelmo.
ELLE. Comò L.1479 con struttura e frontali in noce canaletto.
PILAR. Pouf rivestito in Egeo colore 03.

MEETING. Single-coloured bed upholstered in Egeo fabric col. 28; cylindrical feet in matt Arancio Cotto lacquer.
ELLE. 2-drawer night stand W.793 with structure and fronts in matt Rosa Pompelmo lacquer.
ELLE. Dresser W.1439 with structure and fronts in Canaletto walnut.
PILAR . Pouf upholstered in Egeo fabric col. 03.



Aqua



Disegnato da un'unica superficie in multistrato curvato, Aqua si distingue per il suo morbido profilo in cui un materiale solido viene plasmato come un foglio, ricordando il movimento di un'onda. Grazie alla sua linea sinuosa, il letto infonde alla camera un gradevole senso di leggerezza. Alla testiera possono essere aggiunti lateralmente due vassoi estraibili con la funzione di piano d'appoggio e contenimento essenziale.

Made from a single, curved plywood surface, Aqua bed stands out for its gentle profile created out of a solid material shaped to look like a wave. The curvy line of this bed gives a pleasant feeling of lightness to the room. Two pull-out trays can be added to the sides of the headboard.







AQUA. Letto con struttura e comodini sospesi in rovere dark; basamento in metacrilato.

AQUA. Bed with a Dark Oak structure and night stands. Methacrylate base.



AQUA. Letto in laccato opaco beige argilla; piedini cilindrici laccati in tinta.
EVIA. Poltroncine rivestite in tessuto Regal colore 033, base metallica colore nero.

AQUA. Bed in matt Beige Argilla lacquer with matching-coloured cylindrical feet.
EVIA. Armchair upholstered in Regal fabric col. 033 with black metallic lacquer base.



Plana



Lineare, liscio, essenziale, Plana è l'incontro semplice di base e testiera, due superfici che si intersecano definendo graficamente una struttura estremamente minimal. Il segno netto e deciso lo rendono un letto unico e distinguibile.

In the Plana bed the frame and the headboard meet each other; the straight and clean lines of this bed make it unique.







PLANA. Letto in laccato opaco beige gypso; basamento in metacrilato.
I-NIGHT SYSTEM. Composizione formata da panca a terra e boiserie in appoggio H.384 in laccato opaco grigio nebbia.
IRORI. Tavolino con struttura in laccato opaco nero frac con traverso in laccato metallico brunito.
MIMESI. Specchiera a parete con cornice in laccato metallico brunito.
TECNOPOLIS ANTA NAOS. Armadio battente con anta in pelle Softy colore 724, profili e maniglia in laccato opaco grigio nebbia.

PLANA. Bed in matt Beige Gypso lacquer. Methacrylate base.
I-NIGHT SYSTEM. An arrangement consisting of a floor-standing bench and wall panel H.384 in matt Grigio Nebbia lacquer.
IRORI. Coffee table with a matt Nero Frac lacquered frame and a Burnish metallic lacquer crossbar.
MIMESI. Wall mirror with frame in Burnish metallic lacquer.
TECNOPOLIS WITH NAOS DOORS. Swing door wardrobe with Softy leather col. 724, matt Grigio Nebbia lacquered profiles and handles.



PLANA. Letto in laccato opaco blu lavanda; basamento in metacrilato.

MW. Tavolino con basamento in laccato metallico brunito e piano rotondo ø430 in marmo satinato bianco carrara.

MW. Tavolino con basamento in laccato metallico brunito e piano rotondo ø630 in laccato opaco blu lavanda.

FULLER. Poltrona con rivestimento esterno in pelle vissuta colore Creta 109, rivestimento interno in tessuto Dickinson colore 14.

PLANA. Bed in matt Blu Lavanda lacquer. Methacrylate base.

MW. Coffee table with Burnished metallic lacquer base and Bianco Carrara satin marble round top ø430.

MW. Coffee table with Burnished metallic lacquer base and matt Blu Lavanda lacquered round top ø630.

FULLER. Armchair upholstered on the outside in "aged" leather Creta 109 and on the inside in Dickinson fabric col. 14.

Zero



Il Letto Zero ha uno spirito esibizionista. Nato dal sodalizio di due forme pure come cerchio e quadrato, diventa il protagonista di qualsiasi ambiente in cui venga inserito. Il materasso rettangolare consente l'utilizzo di biancheria standard; nella versione con contenitore l'apertura a due movimenti permette di riordinare il letto da posizione eretta.

The Zero bed shows off the associations of pure forms, a circle and a square one, make it the star of any room. The rectangular mattress enables the use of standard bed linen. In the storage version, the two-position lift-up mechanism allows the tidying up from a standing position.







ZERO. Letto con testiera Bold in tecnopelle Sand colore N/502.
POINT. Tavolino con piano, cassetto girevole e telaio in laccato opaco marrone corteccia.
FULLER. Poltrona con rivestimento esterno in pelle Nuvola colore 179 lino, rivestimento interno in tessuto Indio colore 96.

ZERO. Bed with Bold headboard in upholstered in Sand Tecnopelle col. N/502.
POINT. Coffee table with matt Marrone Corteccia lacquered frame, top and swivel drawer.
FULLER. Armchair upholstered on the outside in Nuvola leather col. 179 lino and on the inside in Indio fabric col. 96.

ZERO. Letto con testiera Bold in pelle Polo colore 860.
EQUIS. Tavolino con basamento in laccato metallico brunito e piano quadrato in marmo satinato bianco carrara.
ICE. Comò con struttura e frontali in laccato opaco beige seta.
CONSOLE SCRITTOIO. Console scrittoio L.1500 in rovere dark.
EVIA. Poltroncina rivestita in tessuto Qaus Res colore 5, base metallica colore Brass.

ZERO. Bed with Bold headboard upholstered in Polo leather col. 860.
EQUIS. Coffee table with Burnish metallic lacquer base and Bianco Carrara satin marble square top.
ICE. Dresser with structure and fronts in matt Beige Seta lacquer.
CONSOLE DESK. Console desk W.1500 in Dark Oak.
EVIA. Armchair upholstered in Qaus Res col. 5 with Brass metallic lacquer base.



Peplo

Peplo system



Peplo



Peplo



Peplo



Peplo



Peplo

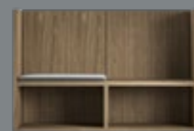

Peplo

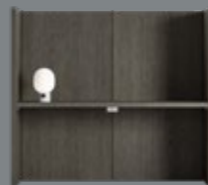

Peplo



Peplo

Peplo



1



2

Progettato per "vestire il mobile", Peplo è un servo dai molteplici utilizzi. Può essere appendiabiti, uso panca/seduta, scrittoio o pedana di appoggio per comò. Può anche farsi centrostanza. Il concept è definito dalle qualità sartoriali e dalla personalizzazione del mobile, in grado di assecondare qualsiasi esigenza e di reinterpretare gli spazi abitativi.

Designed to serve multiple purposes. It can be used to hang clothes, as a bench, a desk or as a base to place a dresser on. It can also be placed in the centre of the room. Its concept is defined by sartorial quality and customisation that can meet any requirement and define the spaces in a home.

1. PEPL0. Composizione monofacciale a singola profondità con panca uso scrittoio in laccato opaco grigio antracite. L.1420 H.1600 P.580.

2. PEPL0. Composizione monofacciale a singola profondità in laccato opaco grigio antracite con asta appendiabiti in finitura brunita. L.1420 H.1600 P.580.

3. PEPL0. Composizione monofacciale a singola profondità con panca uso seduta in noce canaletto e cuscino in tessuto Regal colore 046. L.1804 H.1200 P.580.

4. PEPL0. Composizione monofacciale in noce canaletto con cassettera in appoggio. L.1756 H.1200 P.580. SIBARI. Comò L.1439 con struttura in laccato opaco bianco latte, cornice in laccato opaco verde salvia e top in ceramica calacatta.

1. PEPL0. A single-faced composition with one depth and a bench used as a desk in matt Grigio Antracite lacquer. W.1420 H.1600 D.580.

2. PEPL0. A single-faced composition with one depth, in matt Grigio Antracite lacquer with a burnished finish hanging rail. W.1420 H.1600 D.580.

3. PEPL0. A single-faced composition with one depth and a bench in Canaletto walnut and a cushion in Regal fabric col. 046. W.1804 H.1200 D.580.

4. PEPL0. A single-face composition in Canaletto walnut with a drawer pack. W.1756 H.1200 D.580. SIBARI. Dresser W.1439 with structure and fronts in matt Bianco Latte lacquer, frame in matt Verde Salvia lacquer and Calacatta ceramic top.



3.



4.



PEPLO. Composizione monofacciale a singola profondità in laccato opaco grigio calce con panca uso seduta e cassettera in appoggio. Cuscino in pelle Polo colore 821. L.3560 H.1200 P.580
SIBARI. Comò L.1439 con struttura in rovere tabacco, cornice in laccato opaco marrone corteccia e top in specchio bronzo.

PEPLO. A single-faced composition with one depth in matt Grigio Calce lacquer featuring a bench and with a drawer pack. Cushion in Polo leather col. 821. W.3560 H.1200 D.580
SIBARI. Dresser W.1439 with structure and fronts in Tabacco Oak, frame in matt Marrone Corteccia lacquer and Bronzo mirror top.



PEPLO. Composizione bifacciale a doppia profondità in rovere lince con panca uso scrittoio, cassettera in appoggio, pomoli appendiabiti in finitura Brass e specchio laterale.
L.1804 H.1600 P.1120
SIBARI. Comò L.853 con struttura, cornice e top in laccato opaco grigio Londra.

PEPLO. A double-faced composition with two depths in Lince Oak with a bench, Brass finish round hooks, a side mirror and a drawer pack.
W.1804 H.1600 D.1120.
SIBARI. Dresser W.853 with structure, fronts and top in matt Grigio Londra lacquer.



PEPLO. Composizione bifacciale a doppia profondità in laccato opaco grigio nebbia con panca uso seduta, asta e pomoli appendiabiti in finitura brunita. Cuscino in pelle Polo colore 832.
L.1804 H.1600 P.1120

PEPLO. A double-sided composition with two depths in matt Grigio Nebbia lacquer with a bench, a burnished finish rail and round hooks. Cushion in Polo leather col. 832.
L.1804 H.1600 P.1120



PEPLO. Composizione bifacciale a doppia profondità in castagno naturale con panca uso scrittoio, cassettera in appoggio, pomoli appendiabiti in finitura brunita e specchio laterale. L.1804 H.1600 P.1120
SIBARI. Comò L.853 con struttura e cornice in laccato opaco beige gypso e top in ceramica nero marquinia.
LYRA. Sedia rivestita in pelle polo 860 e base metallica colore nero.

PEPLO. A double-faced composition with two depths in Castagno Naturale with a bench, a drawer pack, burnished finish round hooks and a side mirror. L.1804 H.1600 P.1120
SIBARI. Dresser W.853 with structure, fronts and frame in matt Beige Gypso lacquer and Nero Marquinia ceramic top.
LYRA. Chair upholstered in col. 860 Polo leather with black metallic lacquer base.

Complementi Notte

Night Furniture



Sigma



Sibari



Box



Passion



I-night system



Club



Elle



Globo



I-night system_InclinART



Onyx



Ice

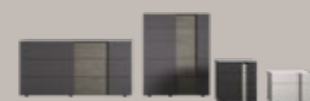

Inside



Jazz



Memories

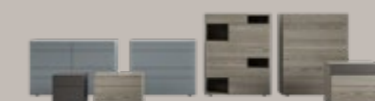

Wing

Sigma

1. Comò L.853 con struttura e frontali in laccato opaco beige argilla, maniglia in laccato metallico brunito. **2.** Comò L.1405 con struttura e frontali in laccato opaco beige argilla, maniglia in laccato metallico brunito. **3.** Comodino a 2 cassetti L.553 con struttura e frontali in laccato opaco blu lavanda, maniglia in laccato metallico brunito. **4.** Comodino a 3 cassetti L.553 con struttura e frontali in laccato opaco blu lavanda, maniglia in laccato metallico brunito.

1. Dresser W.853 with structure and fronts in matt Beige Argilla lacquer. Handles in Burnished metallic lacquer. **2.** Dresser W.1405 with structure and fronts in matt Beige Argilla lacquer. Handles in Burnished metallic lacquer. **3.** 2-drawer night stand W.553 with structure and fronts in matt Blu Lavanda lacquer. Handles in Burnished metallic lacquer. **4.** 3-drawer night stand W.553 with structure and fronts in matt Blu Lavanda lacquer. Handles in Burnished metallic lacquer.

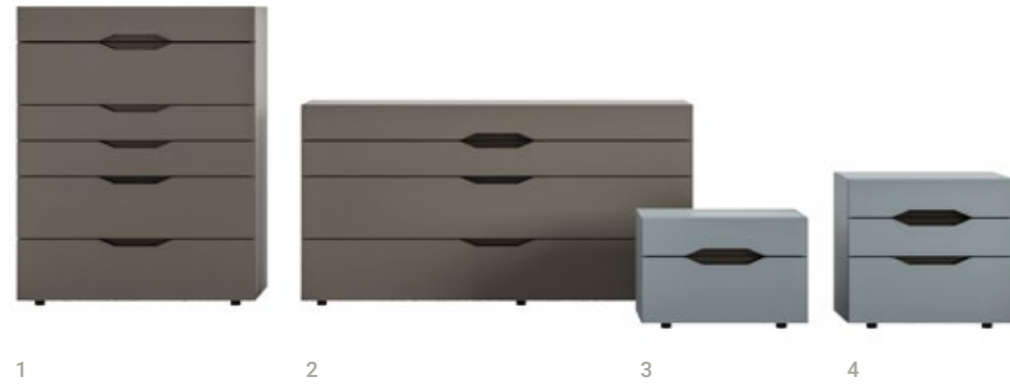

Un segno grafico fine e garbato è quello della maniglia ad incasso che caratterizza Sigma, un gruppo notte lineare che parla lo stesso linguaggio dell'anta Tau e della madia Rho. Il susseguirsi delle maniglie crea un gioco grafico e cromatico di forte carattere. Disponibile in laccato opaco, microline wood o essenza anche con maniglia a contrasto.

The Sigma bedroom furniture with its linear style and recessed handle, matches the Tau door and the Rho sideboard. The pattern created by the handles delivers a strong graphic and chromatic effect. Available in matt lacquer, Microline wood or wood veneer, the handle can also be ordered in a contrasting finish.

P. 169
SIGMA. Comò L.853 con struttura e frontali in rovere avana, maniglia in laccato metallico Iron.
FULLER. Poltrona con rivestimento in pelle Softy colore 272.

SIGMA. Dresser W.853 with structure and fronts in Avana Oak. Handles in Iron metallic lacquer.
FULLER. Armchair upholstered in Softy leather col. 272.



Sibari

1. Comò L.1439 con struttura e frontali in laccato opaco grigio polvere, cornice e top in laccato opaco rosa litchi. 2. Comodino a 2 cassetti L.553 con struttura e frontali in laccato opaco grigio tasmania, cornice laccato opaco nero frac, top in ceramica nero marquinia. 3. Comò L.853 con struttura e frontali in laccato opaco grigio polvere, cornice e top in laccato opaco rosa litchi. 4. Comodino a 3 cassetti L.553 con struttura e frontali in laccato opaco rosa litchi, cornice e top in laccato opaco nero frac.

1. Dresser W.1439 with structure and fronts in matt Grigio Polvere lacquer, matt Rosa Litchi lacquered frame and top. 2. 2-drawer night stand W.553 with structure and fronts in matt Grigio Tasmania lacquer, frame in matt Nero Frac lacquer and Nero Marquinia ceramic top. 3. Dresser W.853 with structure and fronts in matt Grigio Polvere lacquer, matt Rosa Litchi lacquered frame and top. 4. 3-drawer night stand W.553 with structure and fronts in matt Rosa Litchi lacquer, matt Nero Frac lacquered frame and top.



Elementi formalmente essenziali, progettati per ambienti eleganti e gusti raffinati. Li caratterizzano il frontale dal forte spessore con prese maniglia ergonomiche e la personalizzazione del piano incassato disponibile anche in vetro retrolaccato, ceramica, specchio e pelle.

Minimal and sophisticated style for elegant contexts and refined tastes. Thick fronts with ergonomic handles recessed into their edges together with customised, recessed tops also available in rear-lacquered glass, ceramic, mirror and leather.

P. 171
SIBARI. Comò L853 con struttura e frontali in rovere tabacco, cornice laccato opaco marrone corteccia e top in pelle Softy colore 930.

SIBARI. Dresser W.853 with structure and fronts in Tabacco Oak, frame in matt Marrone Corteccia lacquer and Softy leather col. 930 top.



Box

1. Comò L.1417 con struttura e frontali in laccato opaco beige cappuccino. 2. Comò L. 851 con struttura e frontali in laccato opaco beige cappuccino. 3. Comodino a 2 cassetti L. 451 con struttura e frontali in laccato opaco blu lavanda. 4. Comodino a 2 cassetti L. 551 con struttura e frontali in laccato opaco grigio antracite.

1. Dresser W.1417 with structure and fronts in matt Beige Cappuccino lacquer. 2. Dresser W.851 with structure and fronts in matt Beige Cappuccino lacquer. 3. 2-drawer night stand W.451 with structure and fronts in matt Blu Lavanda lacquer. 4. 2-drawer night stand W.551 with structure and fronts in matt Grigio Antracite lacquer.



Come una scatola l'involucro esterno, dallo spessore sottile, ne racchiude i frontali. Un segno esile all'esterno e un tratto marcato all'interno distanzia i frontali cassetto per permetterne la prensilità. Disponibile in laccato opaco.

Integrated handles and thickness of the outer structure wraps around the fronts as if it were a box. Available in matt lacquer.

P. 173

BOX. Comò L.1417 con struttura e frontali in laccato opaco beige cappuccino. TECNOPOLIS ANTA LISCIA. Armadio battente con taglio a mansarda in laccato opaco beige cappuccino.

BOX. Dresser W.1417 with structure and fronts in matt Beige Cappuccino lacquer. TECNOPOLIS WITH LISCIA DOOR. Swing-door wardrobe in matt Beige Cappuccino lacquer with a slanting reduction.



Club

1. Comò L.1439 con struttura e frontali in noce canaletto. **2.** Comò L.853 con struttura e frontali in laccato opaco beige seta. **3.** Comodino a 2 cassetti L.553 con struttura e frontali in laccato opaco verde timo. **4.** Comodino a 3 cassetti L.753 con struttura e frontali in noce canaletto.

1. Dresser W.1439 with structure and fronts in Canaletto walnut. **2.** Dresser W.853 with structure and fronts in matt Beige Seta lacquer. **3.** 2-drawer night stand W.553 with structure and fronts in matt Verde Timo lacquer. **4.** 3-drawer night stand W.753 with structure and fronts in Canaletto walnut.



Famiglia di comò e comodini disponibile in laccato opaco o nella più pregiata essenza. Presenza silenziosa della zona notte, Club si propone all'interno degli ambienti con frontali lineari e prensilità nascoste tra un cassetto e l'altro.

Group of dressers and night stands available in matt lacquer or in the most precious wood veneers. A light presence in the bedroom with linear fronts and recessed handles concealed between the drawers.

P. 175
CLUB. Comò L. 853 con struttura e frontali in laccato opaco verde salvia.

CLUB. Dresser W.853 with structure and fronts in matt Verde Salvia lacquer.



1. Comò L.893 con struttura e frontali in laccato opaco beige seta. **2.** Comò L.1479 con struttura e frontali in laccato opaco grigio antracite. **3.** Comodino a 2 cassetti L.393 con struttura e frontali in laccato lucido giallo bambù. **4.** Comodino a 3 cassetti L.593 con struttura e frontali in laccato opaco grigio antracite.

1. Dresser W.893 with structure and fronts in matt Beige Seta lacquer. 2. Dresser W.1479 with structure and fronts in matt Grigio Antracite lacquer. 3. 2-drawer night stand W.393 with structure and fronts in gloss Giallo Bambù lacquer. 4. 3-drawer night stand W.593 with structure and fronts in matt Grigio Antracite lacquer.



Gruppo essenziale contraddistinto da prese maniglia laterali che esaltano il taglio diagonale dell'unione tra piano e frontali. Elle è femminile e allo stesso tempo grafico, adatto a qualsiasi camera da letto. Disponibile in laccato opaco o lucido, in essenza e color wood.

Minimal night furniture with lateral integrated handles and slanted top and front joint. Although Elle is suitable for any bedroom. Available in matt or gloss lacquer, wood veneer and Color Wood.

P. 177
ELLE. Comò L. 1479 con struttura e frontali in noce canaletto.

ELLE Dresser W.1479 with structure and fronts in Canaletto walnut.

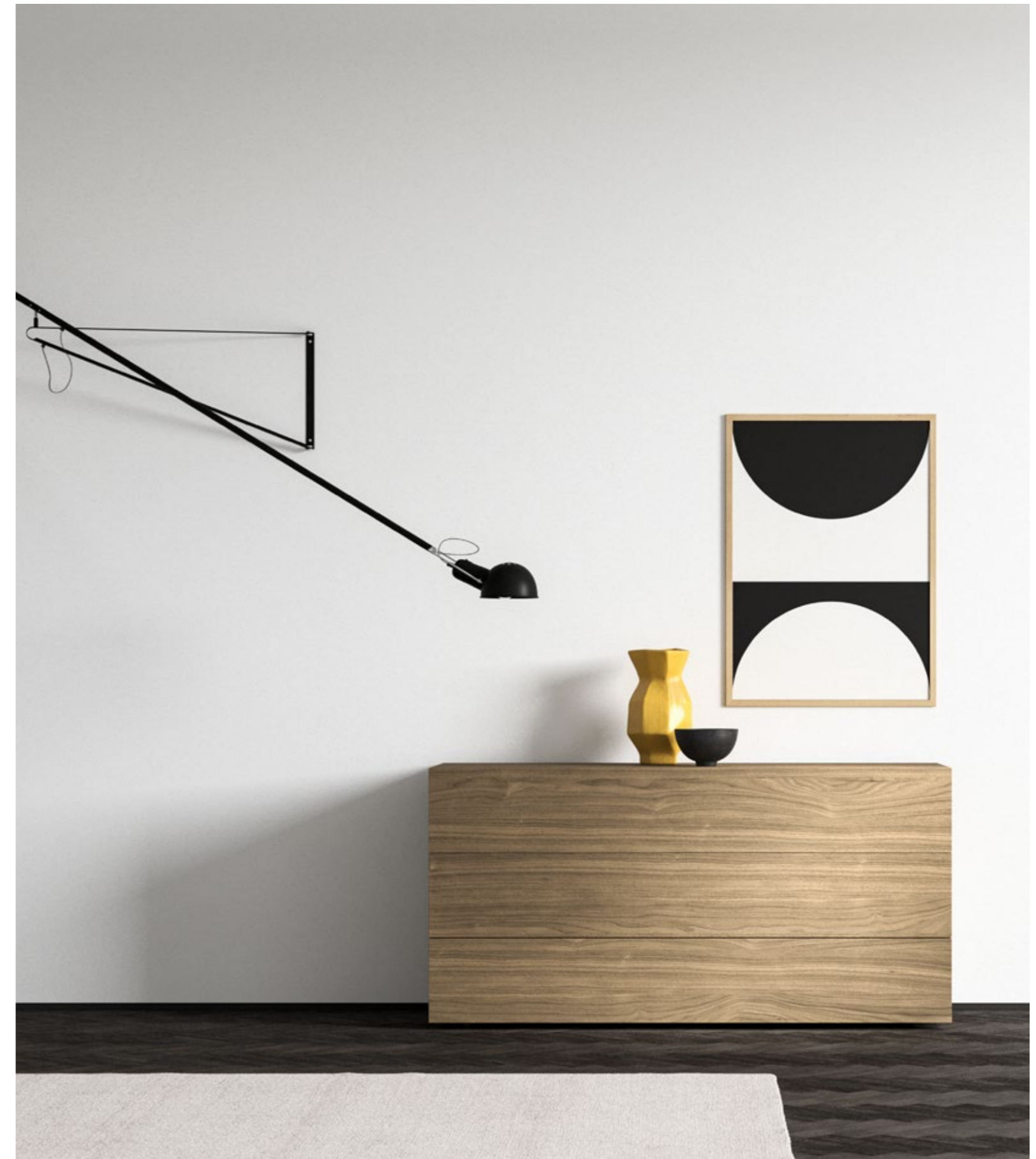

Globo

1. Comodino con struttura, frontali e top in laccato lucido rosa litchi.
2. Comodino con struttura e frontali in laccato lucido grigio nebbia e piano in marmo lucido bianco carrara.
3. Comò con struttura e frontali in laccato opaco grigio nebbia e piano in marmo satinato grigio carnico.

1. Night stand with structure, fronts and top in gloss Rosa Litchi lacquer.
2. Night stand with structure and fronts in gloss Grigio Nebbia lacquer and a Bianco Carrara polished marble top.
3. Dresser with structure and fronts in matt Grigio Nebbia lacquer and a Grigio Carnico satin marble top.



Forme morbide e avvolgenti per comò e comodino in multistrato curvato. I complementi Globo sono dotati di maniglie incavate nei frontali e chiusure soft. Disponibile in laccato lucido o opaco e in versione "gioiello" impreziosite da top in marmo di carrara, nero marquinia o grigio carnico.

Soft lines for a dresser and a night stand in curved plywood. The Globo units have integrated handles and soft-close mechanisms. They are available in gloss or matt lacquer and in the "deluxe" version beautified by a Carrara, Nero Marquinia or Grigio Carnico marble top.

P. 179
GLOBO. Comò con struttura e frontali in laccato opaco rosa pompelmo e piano in marmo satinato nero marquinia.

GLOBO. Dresser with structure and fronts in matt Rosa Pompelmo lacquer and a Nero Marquinia satin marble top.



Ice

1. Comò con struttura e frontali in laccato opaco blu lavanda.
2. Comodino con struttura e frontali in laccato opaco blu vinca.
3. Comò con struttura e frontali in laccato lucido grigio nebbia.

1. Dresser with structure and fronts in matt Blu Lavanda lacquer. 2. Night stand with structure and fronts in matt Blu Vinca lacquer. 3. Dresser with structure and fronts in gloss Grigio Nebbia lacquer.

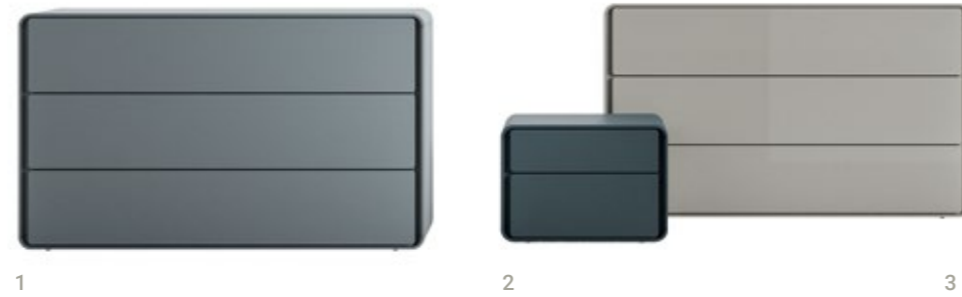

Una forma sinuosa che ricorda gli anni 60 quella di Ice, gruppo notte dalle piacenti linee curve. Spigoli completamente assenti grazie alla presenza di generose raggature e allo scuretto perimetrale, che funge da presa maniglia. Disponibile in laccato opaco o lucido.

Ice – the bedroom furniture with rounded lines and curvy shapes reminding of the 60s. The total absence of sharpness is achieved by generously-rounded radius edges and integrated handles. Available in matt or gloss lacquer.

P. 181
ICE. Comò con struttura e frontali in laccato lucido beige seta.

ICE. Dresser with structure and fronts in gloss Beige Seta lacquer.



Inside

1. Comò L.1446 con struttura e frontali in laccato opaco grigio antracite, inserto in rovere lince. **2.** Comò L. 860 con struttura e frontali in laccato opaco grigio antracite, inserto in rovere lince. **3.** Comodino a 3 cassetti L. 460 con struttura e frontali in laccato opaco nero frac, inserto in pelle Polo colore 932. **4.** Comodino a 2 cassetti L. 460 con struttura e frontali in laccato opaco beige cappuccino, inserto in laccato opaco beige cappuccino.

1. Dresser W.1446 with structure and fronts in matt Grigio Antracite lacquer. Insert in Lince Oak. **2.** Dresser W.860 with structure and fronts in matt Grigio Antracite lacquer. Insert in Lince Oak. **3.** 3-drawer night stand W.460 with structure and fronts in matt Nero Frac lacquer; insert in Polo leather col. 932. **4.** 2-drawer night stand W.460 with structure and fronts in matt Beige Cappuccino lacquer; insert in matt Beige Cappuccino lacquer.



Celato da una peculiare svasatura, l'inserto maniglia del gruppo notte Inside ne è il segno distintivo. Disponibile nella stessa finitura laccata opaca della struttura o a contrasto in essenza, pelle o color Wood.

The Inside bedroom furniture has a special recessed section as handle. It's available in the same matt lacquer finish as the structure or in contrasting wood veneer, leather or Color Wood.

P. 183
INSIDE. Comò L. 1446 con struttura e frontali in laccato opaco beige cappuccino, inserto in laccato opaco beige cappuccino.

INSIDE. Dresser W.1446 with structure and fronts in matt Beige Cappuccino lacquer. Insert in matt Beige Cappuccino lacquer.



Jazz

1. Comò L.860 con struttura e frontali in laccato opaco grigio tasmania, inserto rovere tabacco. 2. Comodino a 2 cassetti L.560 con struttura e frontali in laccato opaco rosa pompelmo, inserto laccato opaco rosa pompelmo. 3. Comodino a 3 cassetti L.560 con struttura e frontali in laccato opaco grigio londra, inserto laccato opaco grigio londra. 4. Comò L.1446 con struttura e frontali in laccato opaco grigio tasmania, inserto laccato opaco grigio tasmania.

1. Dresser W.860 with structure and fronts in matt Grigio Tasmania lacquer. Insert in Tabacco Oak. 2. 2-drawer night stand W.560 with structure and fronts in matt Rosa Pompelmo lacquer. Insert in matt Rosa Pompelmo lacquer. 3. 3-drawer night stand W.560 with structure and fronts in matt Grigio Londra lacquer. Insert in matt Grigio Londra lacquer. 4. Dresser W.1446 with structure and fronts in matt Grigio Tasmania lacquer. Insert in matt Grigio Tasmania lacquer.



Caratterizzato da un taglio obliquo frontale il gruppo Jazz è studiato per essere di forte impatto visivo. La particolare forma dei frontali nasconde dietro questo segno grafico una pratica maniglia ad incasso. La struttura è disponibile in laccato opaco, l'inserto, invece, è disponibile in tonalità o a contrasto in laccato o essenza.

With its oblique recessed fronts, the Jazz bedroom furniture has been designed to have a strong visual impact. The structure is available in matt lacquer. The insert, on the other hand, comes in a matching or contrasting finish in lacquer or wood veneer.

P. 185
JAZZ. Comò L. 1446 con struttura e frontali in laccato opaco beige gypso, inserto laccato opaco nero frac.
TILIA. Sedia con braccioli, struttura in frassino laccato nero, seduta in corda intrecciata colore naturale.

JAZZ. Dresser W.1446 with structure and fronts in matt Beige Gypso lacquer. Insert in matt Nero Frac lacquer.
TILIA. Chair with armrest with Nero lacquered ash frame and seat in Natural-coloured woven rope.



Memories

1. Comò a 6 cassetti L. 1427 con struttura e frontali in laccato opaco grigio antracite. **2.** Comodino a 1 cassetto L. 551 con struttura e frontali in laccato opaco grigio antracite, basamento metallico laccato opaco grigio antracite. **3.** Comodino a 2 cassetti L. 551 con struttura e frontali in laccato opaco grigio calce, interno cassetto in laccato opaco grigio antracite. **4.** Comò a 4 cassetti L. 1427 con struttura e frontali in rovere dark, basamento metallico in finitura brunita. **5.** Comò a 5 cassetti L. 851 con struttura e frontali in laccato opaco grigio antracite.



1. 6-drawer dresser W.1427 with structure and fronts in matt Grigio Antracite lacquer. **2.** 1-drawer night stand W.551 with structure and fronts in matt Grigio Antracite lacquer. Matt Grigio Antracite lacquered metal base. **3.** 2-drawer night stand W.551 with structure and fronts in matt Grigio Calce lacquer. Drawer interior in matt Grigio Antracite lacquer. **4.** 4-drawer dresser W.1427 with structure and fronts in Dark Oak. Burnished finish metal base. **5.** 5-drawer dresser W.851 with structure and fronts in matt Grigio Antracite lacquer.

Ispirati dal fascino degli anni '50, i comodini e comò Memories hanno linee semplici, ma di forte carattere. Disponibili con basamento rialzato, laccato o brunito, o in versione in appoggio a terra con piedini a scomparsa, caratterizzano gli ambienti in maniera versatile sia in finitura laccata che in essenza.

Inspired by the 50s' style, the Memories night stands and dresser feature simple lines with a strong personality. Available with a raised base that can be lacquered or burnished, or floor-standing with concealed feet, they add a distinctive touch to any room. Their versatility is available with a lacquered or wood veneered finish.

P. 187
MEMORIES. Comò a 6 cassetti L. 1427 con struttura e frontali in laccato opaco beige fango, interno cassetto in rovere lince.

MEMORIES. 6-drawer dresser W.1427 with structure and fronts in matt Beige Fango lacquer. Drawer interior in Lince Oak.



Passion

1. Comò rivestito in pelle Nuvola colore 199 Canapa e frontali laccato opaco grigio polvere. 2. Comodino rivestito in pelle Nuvola colore 199 Canapa e frontali laccato opaco grigio polvere. 3. Comò rivestito in pelle Nuvola colore 147 Moretto e frontali laccato opaco marrone corteccia. 4. Comò rivestito in pelle Softy colore 732 e frontali laccato opaco beige argilla.

1. Dresser covered with Nuvola leather col. 199 Canapa and featuring matt Grigio Polvere lacquered fronts. 2. Night stand covered with Nuvola leather col. 199 Canapa and featuring matt Grigio Polvere lacquered fronts. 3. Night stand covered with Nuvola leather col. 147 Moretto and featuring matt Marrone Corteccia lacquered fronts. 4. Dresser covered with Softy leather col. 732 and featuring matt Beige Argilla lacquered fronts.



Cura sartoriale per un complemento composto da un foglio di lamiera piegato, sapientemente rivestito in pelle o tecnopelle. Passion gioca di contrasti con frontali laccati opachi o lucidi.

This bedroom furniture is composed of a curved sheet metal plate covered with leather or Tecnopelle. Passion plays with contrasting matt or gloss coloured fronts.

P. 189
PASSION. Comò rivestito in pelle Nuvola colore 179 lino e frontali laccato opaco beige seta.

PASSION. Dresser covered with Nuvola leather col. 179 Lino and featuring matt Beige Seta lacquered fronts.



I-night system

1. Comodino a 3 cassetti L.450 con struttura e frontali in laccato lucido bianco latte. **2.** Comodino a 2 cassetti L.450 con struttura e frontali in laccato opaco verde salvia. **3.** Comodino a 1 cassetto L.600 con struttura e frontali in laccato lucido grigio polvere. **4.** Comò a 6 cassetti L.750 con struttura e frontali in rovere lince. **5.** Comò a 4 cassetti L.1200 con struttura e frontali in laccato opaco grigio polvere.



1. 3-drawer night stand W.450 with structure and fronts in gloss Bianco Latte lacquer. **2.** 2-drawer night stand W.450 with structure and fronts in matt Verde Salvia lacquer. **3.** 1-drawer night stand W.600 with structure and fronts in gloss Grigio Polvere lacquer. **4.** 6-drawer dresser W.750 with structure and fronts in Lince Oak. **5.** 4-drawer dresser W.1200 with structure and fronts in matt Grigio Polvere lacquer.

Versatile e flessibile: questi i pregi di I-night system, un sistema componibile in svariate combinazioni e dimensioni. Disponibile in più finiture, permette accostamenti materici e cromatici completamente personalizzabili.

Versatility and flexibility are I-night system's main features: a modular system available in many different combinations and sizes. It comes in plenty of finishes that allow many pairings of materials and colours.

P. 191
I-NIGHT SYSTEM. Comò a 4 cassetti L.1200 con struttura e frontali in laccato opaco grigio polvere.
PILAR. Pouf rivestito in tessuto Ubaye colore 59.

I-NIGHT SYSTEM. 4-drawer dresser W.1200 with structure and fronts in matt Grigio Polvere lacquer.
PILAR. Pouf upholstered in Ubaye fabric col. 59.



I-night system_InclinART

1. Comò a 6 cassetti L.900 inclinato a destra con struttura e frontali in laccato opaco beige cappuccino. **2.** Comodino a 2 cassetti L.750 inclinato a destra con struttura e frontali in laccato opaco rosa pompelmo. **3.** Comodino a 3 cassetti L.750 inclinato a destra con struttura e frontali in laccato opaco beige seta. **4.** Comodino a 1 cassetto L.1200 inclinato a destra con struttura e frontali in rovere lince. **5.** Comò a 8 cassetti L.1350 inclinato a destra con struttura e frontali in laccato lucido beige cappuccino.



1. 6-drawer dresser W.900 slanting to the right with structure and fronts in matt Beige cappuccino lacquer. **2.** 2-drawer night stand W.750 slanting to the right with structure and fronts in matt Rosa Pompelmo lacquer. **3.** 3-drawer night stand W.750 slanting to the right with structure and fronts in matt Beige Seta lacquer. **4.** 1-drawer night stand W.1200 slanting to the right with structure and fronts in Lince Oak. **5.** 8-drawer dresser W.1350 slanting to the right with structure and fronts in gloss Beige Cappuccino lacquer.

Declinazione vivace del tradizionale night system, InclinART è contemporaneamente libertà compositiva e spazio contenitivo al servizio di esigenze e gusti differenti. Perfetto connubio di forma e funzione. Panche, mensole, cassettiere e comodini in finitura laccata lucida o opaca, in essenza, color Wood o ecomalta, si adattano perfettamente agli ambienti più dinamici.

A lively version of the traditional Night System, InclinART satisfies different needs and tastes. It's a perfect combination of form and function. Benches, shelves, drawer packs and night stands in matt or gloss lacquer, wood veneer, in Color Wood or Ecomalta, all perfectly adapt to particularly dynamic settings.

P. 193
I-NIGHT SYSTEM_inclinART. Comò a 4 cassetti L.1200 inclinato a sinistra con struttura e frontali in laccato opaco bianco latte.

I-NIGHT SYSTEM_inclinART. 4-drawer dresser W.1200 slanting to the left with structure and fronts in matt Bianco Latte lacquer.



Onyx



1. Comò a 6 cassetti L.853 con struttura e frontali in laccato opaco blu abisso, maniglia Sagitta in finitura brunita. **2.** Comodino a 3 cassetti L.553 con struttura e frontali in laccato opaco grigio nebbia, maniglia Sagitta in finitura brunita. **3.** Comò a 4 cassetti L.853 con struttura e frontali in laccato opaco blu abisso, maniglia Sagitta in finitura brunita. **4.** Comò a 3 cassetti

L.1439 con struttura e frontali in laccato opaco grigio nebbia, maniglia Sagitta in finitura brunita. **5.** Comodino a 2 cassetti L.753 con struttura e frontali in laccato opaco beige argilla, maniglia Sagitta in finitura brunita. **6.** Comodino a 1 cassetto L.553 con struttura e frontali in laccato opaco beige argilla, maniglia Sagitta in finitura brunita.

1. 6-drawer dresser W.853 with structure and fronts in matt Blu Abisso lacquer; burnished metallic Sagitta handles. **2.** 3-drawer night stand W.553 with structure and fronts in matt Grigio Nebbia lacquer; burnished metallic Sagitta handles. **3.** 4-drawer dresser W.853 with structure and fronts in matt Blu Abisso lacquer; burnished metallic Sagitta handles. **4.** 3-drawer

dresser W.1439 with structure and fronts in matt Grigio Nebbia lacquer; burnished metallic Sagitta handles. **5.** 2-drawer night stand W.753 with structure and fronts in matt Beige Argilla lacquer; burnished metallic Sagitta handles. **6.** 1-drawer night stand W.553 with structure and fronts in matt Beige Argilla lacquer; burnished metallic Sagitta handle.

Un'estetica senza tempo quella di Onyx, gruppo notte essenziale impreziosito dalla maniglia, disponibile in diverse tipologie e finiture. Adatto ad ogni tipo di ambiente grazie alla sua versatilità.

The minimal Onyx bedroom furniture has a timeless aesthetics enriched by the handle available in different types and finishes. Thanks to its versatility, this line is suitable for any setting.

P. 195
ONYX. Comò a 3 cassetti L.1205 con struttura e frontali in laccato lucido bianco latte, maniglia Sagitta in finitura brunita.

ONYX. 3-drawer dresser W.1205 with structure and fronts in gloss Bianco Latte lacquer; burnished metallic Sagitta handles.



Wing



1. Comò a 8 cassetti L.1105 con struttura e frontali in laccato opaco blu lavanda. **2.** Comodino a 2 cassetti L.353 con struttura e frontali in laccato opaco grigio Londra. **3.** Comodino a 2 cassetti L.553 in rovere avana. **4.** Comò a 4 cassetti L.853 con struttura e frontali in laccato opaco blu lavanda.

5. Comò a 6 cassetti L.853 con struttura, frontali e vani a giorno in rovere avana. **6.** Comò a 6 cassetti L.853 in rovere avana. **7.** Comodino a 3 cassetti L. 753 con struttura e frontali in rovere avana e un frontale in laccato opaco grigio Londra.

1. 8-drawer dresser W.1105 with structure and fronts in matt Blu Lavanda lacquer. **2.** 2-drawer night stand W.353 with structure and fronts in matt Grigio Londra lacquer. **3.** 2-drawer night stand W.553 with structure and fronts in Avana Oak. **4.** 4-drawer dresser W.853 with structure and fronts in matt Blu Lavanda

lacquer. **5.** 6-drawer dresser W.853 with structure, fronts and open compartments in Avana Oak. **6.** 6-drawer dresser W.853 with structure and fronts in Avana Oak. **7.** 3-drawer night stand W.753 with structure and fronts in Avana Oak and one front in matt Grigio Londra lacquer.

Volumi puri, interrotti dalla traccia laterale che diventa prensilità: questa è l'essenza dei complementi notte Wing. Una famiglia ricca di varianti e dimensioni disponibili in molteplici finiture, anche a contrasto.

Pure volumes interrupted by a lateral integrated handle: this is the essence of the Wing units. A group with a wide range of dimensions and finishes, even contrasting ones.

P. 197
WING. Comò 6 cassetti L. 853 con struttura, frontali e vani a giorno in noce canaletto.

WING. 6-drawer dresser W.853 with structure, fronts and open compartments in Canaletto walnut.



Accessori

Accessories



Pouf Quadrato



Swing console



I-night system



Cali

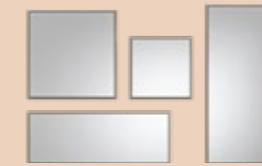

Mimesi



Relevé



I-night system_InclinART



Pilar



Relevé



Point



Relevé



Console



Relevé



Tuttospecchio



Console



Diadro

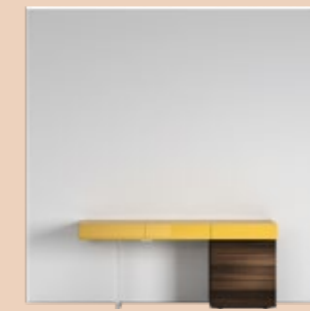

Swing



Swing console

Relevé

scrivania/desk



1



2

Inconfondibile per l'eleganza che contraddistingue tutti i mobili della serie, disegnato nel richiamo di un iconico passo di danza. Un normale scrivania, adatto ad un utilizzo personale, riservato, intimo. Oppure anche in variante "home office", con una delle gambe appoggiata ad una funzionale cassetiera a tre cassetti.

Unmistakable elegance distinguishes all the furniture in this range which is designed alluding to an iconic dance step. An everyday desk, well-suited to be used in a personal, confidential and intimate way. It's also available in the home-office version with one of its legs resting on a practical, three-drawer unit.

1. Scrivania con struttura e top in rovere dark. Comodino CLUB a 3 cassetti in laccato opaco grigio tasmania.
2. Scrivania con struttura in rovere dark e top in ceramica nero marquinia.

1. Desk with a Dark Oak frame and top. CLUB 3-drawer night stand in matt Grigio Tasmania lacquer. 2. Desk with a Dark Oak frame and a Nero Marquinia ceramic top.

P 201
RELEVÉ. Scrivania con struttura in noce canaletto e top in pelle Polo colore 860.
CLUB. Comodino a 3 cassetti L.553 con struttura e frontali in laccato opaco beige seta.
PILAR. Pouf rivestito in pelle Polo colore 860.

RELEVÉ. Desk with a Canaletto walnut frame and a top in Polo leather col. 860.
CLUB. 3-drawer night stand W. 553 with matt Beige Seta structure and fronts.
PILAR. Pouf upholstered in Polo leather col. 860.



Swing console

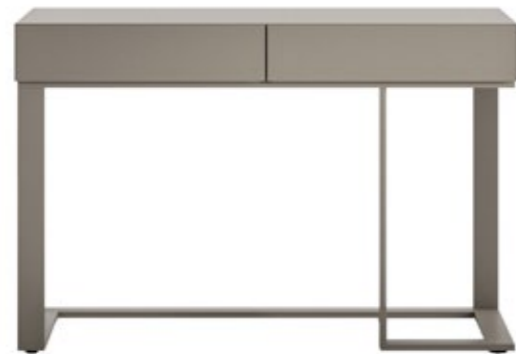

1



2

Pulizia formale e volumetrie nette descrivono Swing rendendolo un elemento versatile, pensato per valorizzare gli ambienti notte, ma può dimostrarsi adatto anche a molti altri contesti. Il piano d'appoggio, comprensivo di cassetti, è a scelta laccato lucido o opaco, in essenza o colorwood; il basamento metallico è laccato in tinta. Misura unica disponibile.

Swing features clean-cut lines and flowing volumes resulting in a versatile element which has been designed to enhance bedrooms, although it can adapt to many other contexts as well. The top and drawers are available in a gloss or matt finish, wood veneered or in Colorwood. The metal base is lacquered in the same shade. Available in one size only.

1. Console scrittoio con struttura e basamento in laccato opaco beige argilla. 2. Console scrittoio con struttura rovere dark e basamento in laccato opaco beige argilla.

1. Console desk with frame and base in matt Beige Argilla lacquer. 2. Console desk with a Dark Oak frame and a base in matt Beige Argilla lacquer.

P 203
SWING CONSOLE. Scrittoio con struttura laccato opaco nero frac.
PILAR. Pouf rivestito in tessuto Elissos colore 5.
MIMESI. Specchiera a parete con cornice in laccato metallico brunito.

SWING CONSOLE. Console desk with frame and base in matt Nero Frac lacquer.
PILAR. Pouf upholstered in Elissos fabric col.5.
MIMESI. Wall mirror with frame in Burnish metallic lacquer.



Swing



1



2

Progetto modulare componibile, Swing è un sistema che può essere sospeso o a terra, composto da un modulo orizzontale con cassetti accostato ad elementi contenitivi a sviluppo verticale. Disponibile in laccato lucido o opaco, essenza o color wood, con la possibilità eventuale di personalizzare i frontali dei cassetti anche in diverse finiture.

A project for modular, fitted units, the Swing system can be wall-hung or floor-standing and is composed of a horizontal module with drawers paired with vertical storage units fitted one on top of the other. It's available in gloss or matt lacquer, wood veneer or in Color Wood and the drawer fronts can even be customised with different finishes.

1. Console componibile composta da un elemento orizzontale a 3 cassetti in laccato lucido giallo bambù ed un elemento verticale a 3 cassetti in rovere tabacco. 2. Console componibile composta da due elementi orizzontali a 2 cassetti accostati in laccato opaco beige cappuccino e due elementi verticali a 3 cassetti in rovere tabacco.

1. Modular console table composed of a horizontal element with 3 drawers in gloss Giallo Bambù lacquer and a vertical 3-drawer pack in Tabacco Oak. 2. Modular console table composed of two horizontal elements in matt Beige Cappuccino lacquer with 2 drawers fitted side-by-side and two, vertical, 3-drawer packs in Tabacco Oak.

P 205
SWING. Console composta da un elemento orizzontale a 3 cassetti in rovere dark e un elemento verticale a 3 cassetti in rovere dark con frontali beige seta opaco.
MIMESI. Specchiera a parete con cornice in laccato metallico brunito.
TILIA. Sedia con struttura in frassino laccato nero, seduta in corda intrecciata colore naturale.

SWING. Modular console table composed of a horizontal element with 3 drawers in Dark Oak and a vertical 3-drawer pack in dark oak with matt Beige Seta lacquered fronts.
MIMESI. Wall mirror with frame in Burnish metallic lacquer.
TILIA. Chair with Nero lacquered ash frame and seat in Natural-coloured woven rope.



I-night system



1



2

Versatile e flessibile, I-night system è un sistema componibile disponibile in svariate combinazioni e dimensioni. Le numerose finiture permettono accostamenti materici e cromatici completamente personalizzabili.

I-night system is a versatile and flexible modular system available in various combinations and sizes. Its many finishes allow fully-customisable pairings in terms of materials and colours.

1. Composizione home-office formata da panca sospesa L.1800 in rovere lince e basi sospese L.450 in laccato lucido grigio antracite. **2.** Composizione home-office formata da panca sospesa L.1800 in laccato opaco rosso vermut e base a terra L.1350 in rovere lince

1. A home-office arrangement consisting of a wall-hung bench W.1800 in Lince Oak and wall-hung base units W.450 in gloss Grigio Antracite lacquer. **2.** A home-office arrangement consisting of a wall-hung bench W.1800 in matt Rosso Vermut lacquer and a floor-standing base unit W.1350 in Lince Oak.

P 207
I-NIGHT SYSTEM. Composizione home-office formata da panca sospesa L.1500 e base sospesa ad un cassetto L.750 in rovere dark. Base a terra L.1500 in laccato lucido beige cappuccino. POUF QUADRATO. Pouf rivestito in pelle Softy colore 728.

I-NIGHT SYSTEM. A home-office arrangement consisting of a wall-hung bench W.1500 and a wall-hung unit W.750 in Dark Oak. Floor-standing base unit W.1500 in gloss Beige Cappuccino lacquer. POUF QUADRATO. Pouf upholstered in Softy leather col. 728.



I-night system_inclinART



1



2

Declinazione vivace del tradizionale night system, InclinART è contemporaneamente libertà compositiva e spazio contenitivo al servizio di esigenze e gusti differenti. Perfetto connubio di forma e funzione. Panche, mensole, cassettiere e comodini in finitura laccata lucida o opaca, in essenza, color wood o ecomalta, si adattano perfettamente agli ambienti più dinamici.

A lively version of the traditional Night System, InclinART stands for freedom of arrangement and for storage units that satisfy different needs and tastes. It's a perfect combination of form and function. Benches, shelves, drawer packs and night stands in matt or gloss lacquer, wood veneer, in Color Wood or Ecomalta, all perfectly adapt to particularly dynamic settings.

1. Composizione home-office formata da panca sospesa L.1800 inclinata a destra in rovere avana e due comodini sospesi a 1 cassetto L.600 inclinati a destra e sinistra in laccato opaco arancio cotto. **2.** Composizione home-office formata da panca sospesa L.1800 inclinata a destra in rovere avana e comodino a 3 cassetti L.600 inclinato a sinistra laccato opaco verde spiga.

1. A home-office arrangement consisting of a wall-hung bench slanting to the right W.1800 in Avana Oak and two wall-hung, 1-drawer night stands slanting to the right and left W.600 in matt Arancio Cotto lacquer. **2.** A home-office arrangement consisting of a wall-hung bench slanting to the right W.1800 in Avana Oak and a 3-drawer night stand slanting to the left W.600 in matt Verde Spiga lacquer.

P 209
I-NIGHT SYSTEM inclinART. Composizione home-office formata da panca sospesa L.1800 inclinata a destra e comodino a 3 cassetti L.600 inclinato a sinistra in laccato opaco nero frac. EVIA. Poltrona con struttura in frassino laccato nero e rivestimento in tessuto St. Moritz colore 159.

I-NIGHT SYSTEM_inclinART. A home-office arrangement consisting of a wall-hung bench slanting to the right W.1800 and a 3-drawer night stand slanting to the left W.600 in matt Nero Frac lacquer. EVIA. Armchair with Nero lacquered ash legs upholstered in St. Moritz fabric col.159.



Console scrittoio



1



2

Estensione del comò, il piano scrittoio in appoggio alla cassettera ne completa la funzione. Posizionato liberamente e disponibile in svariate finiture, non necessita di fissaggio a muro.

An extension of the dresser, the desk resting on top of the drawer pack completes its function. It can be positioned as needed and is available in various finishes; it does not need to be secured to the wall.

1. Console scrittoio L.1800 in noce canaletto e comò ICE in laccato opaco grigio nebbia. **2.** Console scrittoio L.1800 in noce canaletto e comò Wing a 8 cassetti L.1405 in noce canaletto.

1. Console desk W.1800 in Canaletto walnut paired with an ICE dresser in matt Grigio Nebbia lacquer. **2.** Console desk W.1800 in Canaletto walnut paired with a WING 8-drawer dresser W.1405 in Canaletto walnut.

P 211
CONSOLE SCRITTOIO. Console scrittoio L.1500 in rovere tabacco. SIGMA. Comò L1405 in laccato opaco beige argilla con maniglia in laccato metallico brunito. INDIRA. Poltroncina con schienale esterno plissettato rivestita in pelle Nuvola colore 179 lino. Struttura in frassino laccato nero.

CONSOLE SCRITTOIO. Console desk W.1500 in Tabacco Oak. SIGMA. Dresser W1405 in matt Beige Argilla lacquer with burnished metallic lacquered handles. INDIRA. Armchair with pleated back upholstered in Nuvola leather col.179 lino. Nero lacquered ash frame.



Relevé

panca / bench

1. Panca L. 1768 con struttura in rovere dark e piano in specchio bronzo. **2.** Panca L. 982 con struttura e piano in rovere dark.

1. Bench W 1768 with a Dark Oak structure and a Bronzo mirror top. **2.** Bench W 982 with a Dark Oak structure and top.



1



2

Inconfondibile per l'eleganza che contraddistingue tutti i mobili della serie, anche questo elemento è stato ispirato da un iconico passo di danza. La panca scendiletto Relevé ha la struttura in essenza e il piano personalizzabile, anche con tacco a contrasto in laccato opaco.

This entire range of furniture is distinguished by unmistakable elegance, including this element inspired by an iconic dance step. The Relevé bench standing at the foot of the bed has a wood veneered structure and a customisable top. The inside of the legs is even available in a contrasting matt lacquered shade.

P. 213
RELEVE. Panca L. 1768 con struttura in noce canaletto e piano in pelle Nuvola colore 147 moretto.
DELFI. Testiera H.950 rivestita in pelle Nuvola colore 199 canapa e pomoli in finitura brunita. Ring imbottito in pelle Nuvola colore 199 canapa.

RELEVE. Bench W.1768 with Canaletto walnut structure and a Nuvola leather col. 147 Moretto top.
DELFI. 950-mm high headboard in upholstered in Nuvola leather col. 199 Canapa with burnished finish knobs. Padded bed frame upholstered in Nuvola leather col. 199 Canapa.



Diadro

panca / bench

1. Panca con piano in noce canaletto e basamento in laccato opaco beige cappuccino. **2.** Panca con piano in castagno naturale e basamento in laccato opaco grigio londra.

1. Bench with a Canaletto walnut top and a base in matt Beige Cappuccino lacquer. **2.** Bench with a Castagno Naturale top and a matt Grigio Londra lacquered base.



1



2

Lo spesso piano in essenza caratterizza marcatamente la panca Diadro. La solida struttura in metallo è determinata da lame parallele saldamente congiunte tra loro. La sua linea rigorosa la rende un elemento versatile, capace di star bene dalla zona notte al living.

The same wood veneered top clearly distinguishes the Diadro bench. The sturdy metal frame is made of solid, parallel legs firmly connected to each other. Its clean-cut lines result in a versatile piece of furniture that looks beautiful both in the bedroom and the living room.

P. 215
DIADRO. Panca con piano in rovere dark e basamento in laccato opaco nero frac.

DIADRO. Bench with a Dark Oak top and a matt Nero Frac lacquered base.



Cali

panca / bench

1. Panca imbottita con rivestimento in pelle Polo colore 856, piedini cilindrici in laccato metallico brass. **2.** Panca imbottita con rivestimento in tessuto St. Moritz colore 146, piedini cilindrici in laccato metallico brass.

1. Padded bench upholstered in Polo leather col. 856 featuring cylindrical feet in Brass metallic lacquer. **2.** Padded bench upholstered in St. Moritz fabric col. 146 featuring cylindrical feet in Brass metallic lacquer.



1



2

Una panca morbida e comoda, che esprime la sua personalità nella spessa imbottitura. La seduta è disponibile rivestita in tessuto, pelle e tecnopelle, mentre quattro gambe sottili la sostengono, donandole un tocco contemporaneo. Può stare davanti al letto, in corridoio, nel living, ovunque venga posizionata è in grado di parlare di comfort ed elegante essenzialità.

A soft and comfortable bench that expresses its personality through its padding. The seat is available upholstered in fabric, leather or Tecnopelle with four, slim legs giving it a contemporary touch. It can stand in front of the bed, in the corridor, in the living room or anywhere else.

P. 217

CALI. Panca imbottita con rivestimento in pelle vissuta colore Creta 109, piedini cilindrici in laccato metallico brunito.

CALI. Padded bench upholstered in "aged" leather Creta 109 featuring cylindrical feet in Burnished metallic lacquer.



Point

1. Tavolino con piano e telaio in laccato opaco verde salvia. **2.** Tavolino con piano, cassetto girevole e telaio in laccato opaco verde timo.

1. Coffee table with top and frame in matt Verde Salvia lacquer. **2.** Coffee table with top, swivel drawer and frame in matt Verde Timo lacquer.



1



2

Un disegno che trova pieno riscontro nel nome, per un tavolino tondo con gamba laterale che può essere utilizzato come appoggio laterale di servizio, disegnando un punto sulla superficie su cui si appoggia. Disponibile anche con cassetto girevole.

A round coffee table with a lateral leg that can be used as a side table, like a point on the surface where it stands. Also available with a swivel drawer.

P. 219
POINT. Tavolino con piano, cassetto girevole e telaio in laccato opaco beige argilla
ZERO. Letto con testiera Bold in tecnopelle sand colore N/502.

POINT. Coffee table with top, swivel drawer and frame in matt Beige Argilla lacquer.
ZERO. Bed with Bold headboard upholstered in Sand Tecnopelle col. N/502.



Pilar



1. Pouf rivestito in tessuto Regal colore 046 con piano in noce canaletto. 2. Pouf rivestito in pelle Polo colore 854. 3. Pouf rivestito in tessuto Dickinson colore 12.

1. Pouf upholstered in Regal fabric col. 046 with Canaletto walnut top. 2. Pouf upholstered in Polo leather col. 854. 3. Pouf upholstered in Dickinson fabric col. 12.

Il volume è cilindrico, regolare, dalla linea compatta. La superficie superiore, disegnata in forma concava, permette di appoggiare comodamente il vassoio in laccato o essenza che lo completa, trasformandolo in un pratico e utile piano di appoggio. Può essere realizzato in pelle, tecnopelle o tessuto, non sfoderabile.

Cylindrical, regular volumes and compact lines. The shape of the top allows the setting of a lacquered or wooden tray that transforms it into a useful support surface. It is available in non-removable leather, Tecnopelle or fabric.

P 221
PILAR. Pouf rivestito in tessuto Regal colore 036.
BOX. Comò con struttura e frontali in laccato opaco arancio cotto.

PILAR. Pouf upholstered in Regal fabric col. 036.
BOX. Dresser with matt Arancio Cotto lacquered structure and fronts.



Pouf quadrato



1. Pouf rivestito in pelle Polo colore 832. **2.** Pouf rivestito in tessuto Qaus Res colore 60. **3.** Pouf rivestito in tessuto Guarei colore 04. **4.** Pouf rivestito in pelle Nuvola colore 179 lino.

1. Pouf upholstered in Polo leather col. 832. **2.** Pouf upholstered in Qaus Res fabric col. 60. **3.** Pouf upholstered in Guarei fabric col. 04. **4.** Pouf upholstered in Nuvola leather col. 179 Lino.

Elemento decorativo poliedrico e versatile, rivestito in pelle, tecnopelle o tessuto, il pouf ha una forma giocosa e si adatta a qualsiasi ambiente della casa.

A multipurpose, versatile pouf covered with leather, Tecnopelle or fabric, it has a funny shape and can be used in any room.

P 223
POUF QUADRATO. Pouf rivestito in tessuto Regal colore 013 e tessuto St Moritz colore 159.
SWING. Console con struttura, frontali e basamento laccato opaco rosa pompelmo.

POUF QUADRATO. Pouf upholstered in Regal fabric col. 013 and St. Moritz fabric col. 159.
SWING. Console table with structure, fronts and base in matt Rosa Pompelmo lacquer.



Mimesi

Specchiere a parete con cornice
in laccato metallico iron.

Wall mirrors with Iron metallic
lacquered frame.

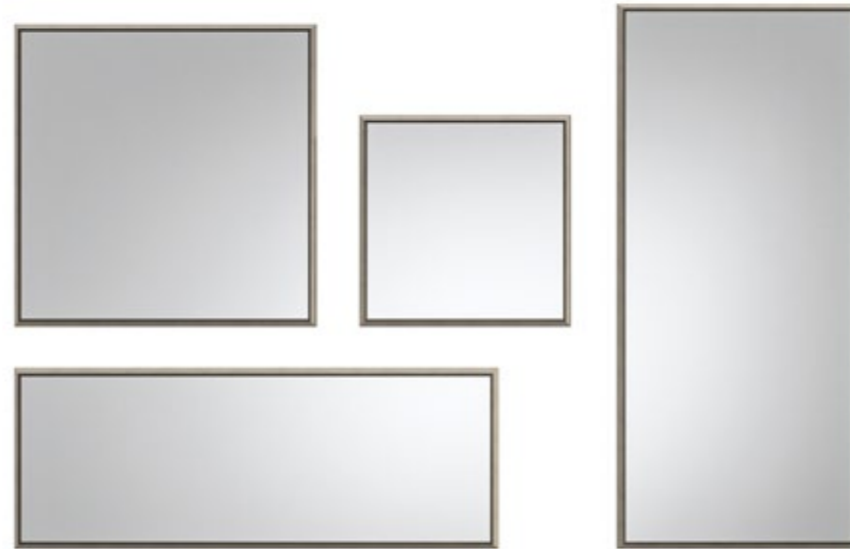

Forme verticali e orizzontali contengono uno specchio elegantemente messo in risalto da una cornice svasata in legno, verniciata in finitura metallica.

Vertical and horizontal shapes contain a mirror that is elegantly enhanced by a tapered, wooden frame with a metallic lacquered finish.

P. 225

MIMESI. Specchiera a parete con cornice in laccato metallico brunito.

EULERO. Tavolino con basamento in laccato metallico brunito e piano quadrato 450x450 in marmo satinato bianco carrara.

EULERO. Tavolino con basamento in laccato metallico brunito e piano quadrato 620x620 in marmo satinato bianco carrara.

MIMESI. Wall mirror with frame in Burnished metallic lacquer.

EULERO. Coffee table with Burnished metallic lacquer frame and square 450x450 Bianco Carrara satin marble top.

EULERO. Coffee table with Burnished metallic lacquer frame and square 620x620 Bianco Carrara satin marble top.



Tuttospecchio



Un unico sviluppo verticale e inclinato, per una specchiera poggiata a parete e a terra su due solidi piedini di metallo cromato. Precisa e a tutto profilo, con specchio su cinque lati.

A single vertical and inclined shape for a mirror that leans against the wall and stands on the floor on two, sturdy, chromed metal legs. This mirror extends to all five sides of its streamlined design.

Specchiera a terra con piedini cromati.
Floor mirror with chromed metal legs.

P. 227
TUTTOSPECCHIO. Specchiera a terra con piedini cromati.
TOWER. Libreria finitura grigio antracite su metallo con basamento in marmo bianco carrara.
POUF. Pouf rivestito in tessuto Barbat colore 17.

TUTTOSPECCHIO. Floor-standing mirror with chromed feet.
TOWER. Metal bookcase with a Grigio Antracite finish and a Bianco Carrara marble base.
POUF QUADRATO. Pouf upholstered in Barbat fabric col. 17.



P technical

Relevé

P 10

Design by gherardiarchitetti



- Struttura realizzata in legno naturale impiallacciato in essenza.
- Disponibile con testiera impiallacciata in essenza o rivestita in tecnopelle o pelle. La testiera rivestita non è mai sfoderabile.
- La superficie interna delle gambe può essere laccata opaca.
- Wood veneered, natural timber structure.
- The headboard is available in wood veneer or upholstered in Tecnopelle or leather. The headboard upholstered is never removable.
- The inner surface of the legs can be matt lacquered.

TECHNICAL DRAWINGS

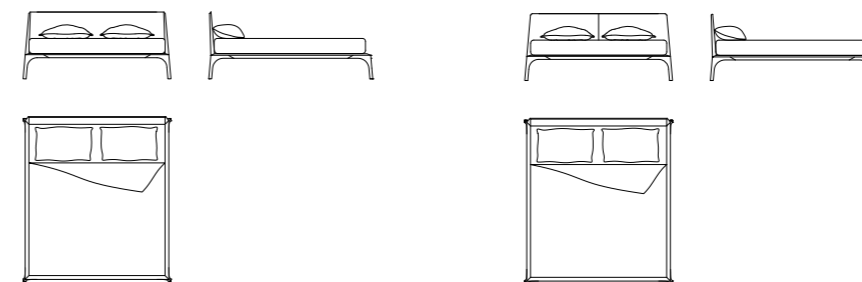

DIMENSIONI | SIZE

L/W 1768	P/D 2168	H 885 (materasso mattress 1600x2000)
L/W 1968	P/D 2168	H 885 (materasso mattress 1800x2000)
L/W 1718	P/D 2219	H 885 (materasso mattress QUEEN SIZE)
L/W 2108	P/D 2219	H 885 (materasso mattress KING SIZE)

Cali

P 20

Design by gherardiarchitetti



- Letto con struttura realizzata in pannelli di particelle, rivestita in tessuto, pelle o tecnopelle. Il rivestimento e' sempre sfoderabile.
- Caratterizzato da due cuscini in piuma rivestiti in tessuto, pelle o tecnopelle sempre sfoderabili. I cuscini sono disponibili anche con un rivestimento in contrasto rispetto a quello della struttura.

- Bed with a particleboard structure upholstered in fabric, leather or Tecnopelle. The cover is always removable.
- Featuring two feather cushions upholstered in removable fabric, leather or Tecnopelle. The cushions are also available with a cover that contrasts with the structure.

TECHNICAL DRAWINGS

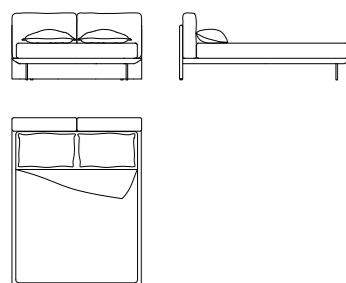

DIMENSIONI | SIZE

L/W 1715	P/D 2276	H 886 (materasso mattress 1600x2000)
L/W 1915	P/D 2276	H 886 (materasso mattress 1800x2000)
L/W 1715	P/D 2328	H 886 (materasso mattress QUEEN SIZE)
L/W 2055	P/D 2328	H 886 (materasso mattress KING SIZE)

Fez

P 28

Design by gherardiarchitetti



- Letto con struttura realizzata in pannelli di particelle, rivestita in tessuto, pelle o tecnopelle. Il rivestimento è sempre sfoderabile.
- Caratterizzato da una testiera formata da due cuscini in falda accoppiata e maglina rivestiti in tessuto, pelle o tecnopelle. Il rivestimento è sempre sfoderabile.

- Bed with a particleboard structure upholstered in fabric, leather or Tecnopelle. The cover is always removable.
- Featuring a headboard made up of two cushions consisting of bonded wadding and jersey upholstered in fabric, leather or Tecnopelle. The cover is always removable.

TECHNICAL DRAWINGS

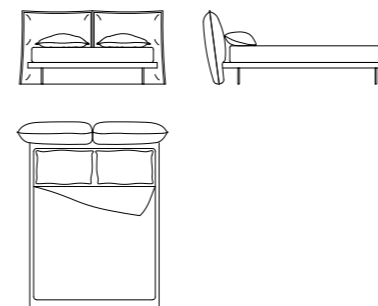

DIMENSIONI | SIZE

L/W 1930	P/D 2343	H 970 (materasso mattress 1600x2000)
L/W 2130	P/D 2343	H 970 (materasso mattress 1800x2000)
L/W 1930	P/D 2395	H 970 (materasso mattress QUEEN SIZE)
L/W 2270	P/D 2395	H 970 (materasso mattress KING SIZE)

Shelby

P 36

Design by gherardiarchitetti



- Letto con struttura realizzata in pannelli di particelle, rivestita in tessuto o tecnopelle. Il rivestimento è sempre sfoderabile.
- Caratterizzato da una testiera sagomata in espanso e falda accoppiata rivestita in tessuto o tecnopelle sempre sfoderabile. La parte frontale della testiera è sempre rivestita con il medesimo materiale del giroletto. Nella versione bicolore il retro della testiera può essere rivestito con materiale in contrasto, anche in pelle.
- La testiera, sempre retrofinita, si contraddistingue per una serie di cuciture verticali in tono con il rivestimento.

- Bed with a particleboard structure upholstered in fabric or Tecnopelle. The cover is always removable.
- Featuring a shaped headboard made of foam and bonded wadding upholstered in removable fabric or Tecnopelle. The front of the headboard is always upholstered in the same material used for the bed frame. In the dual-coloured version the back of the headboard can be upholstered with a contrasting material, even leather.
- The headboard is always finished on the rear and stands out because of a set of vertical, stitched lines tone-on-tone with the cover.

TECHNICAL DRAWINGS

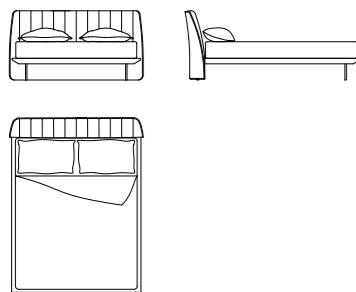

DIMENSIONI | SIZE

L/W 1770	P/D 2313	H 915 (materasso mattress 1600x2000)
L/W 1970	P/D 2313	H 915 (materasso mattress 1800x2000)
L/W 1770	P/D 2365	H 915 (materasso mattress QUEEN SIZE)
L/W 2110	P/D 2365	H 915 (materasso mattress KING SIZE)

Zuko

P 44

Design by Presotto



- Letto con struttura realizzata in pannelli di particelle, rivestita in tessuto o tecnopelle. Il rivestimento è sempre sfoderabile.
- Caratterizzato da una testiera sagomata in espanso e falda accoppiata rivestita in tessuto o tecnopelle sempre sfoderabile. La parte frontale della testiera è rivestita con il medesimo materiale del giroletto. Nella versione bicolore i fianchi e il retro della testiera possono essere rivestiti con materiale in contrasto, anche in pelle.
- La testiera, sempre retrofinita, si contraddistingue per una serie di cuciture verticali in tono con il rivestimento.

- Bed with a particleboard structure upholstered in fabric or Tecnopelle. The cover is always removable.
- Featuring a shaped headboard made of foam and bonded wadding covered in removable fabric or Tecnopelle. The front of the headboard is upholstered in the same material used for the bed frame. In the dual-coloured version the sides and the back of the headboard can be upholstered in a contrasting material, even leather.
- The headboard is always finished on the rear and stands out because of a set of vertical, stitched lines tone-on-tone with the cover.

TECHNICAL DRAWINGS

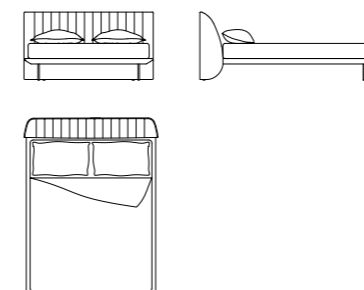

DIMENSIONI | SIZE

L/W 1709	P/D 2357	H 900 (materasso mattress 1600x2000)
L/W 1909	P/D 2357	H 900 (materasso mattress 1800x2000)
L/W 1709	P/D 2409	H 900 (materasso mattress QUEEN SIZE)
L/W 2049	P/D 2409	H 900 (materasso mattress KING SIZE)

Plica

P 52

Design by gherardiarchitetti



- Letto con struttura sagomata realizzata in pannelli di particelle rivestita in tessuto, tecnopelle o pelle (sempre sfoderabile).
- Nella versione con contenitore il sottoring in legno plissettato può essere impiallacciato in essenza o rivestito nella stessa finitura del letto; disponibile anche nella versione alzata da terra con piedino.

- Bed with a shaped structure made of particleboard upholstered in removable fabric, Tecnopelle or leather.
- In the storage version the bed frame base in pleat-effect wood can be wood veneered or upholstered in the same finish used for the bed. It also comes in a version raised off the floor on feet.

TECHNICAL DRAWINGS

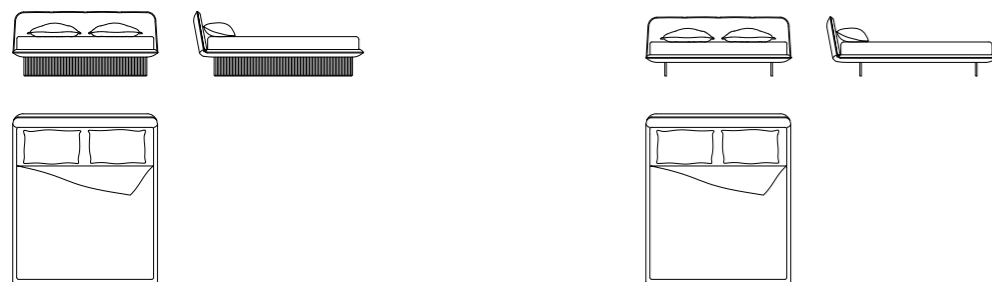

DIMENSIONI | SIZE

L/W 1755	P/D 2263	H 905 (materasso mattress 1600x2000)
L/W 1955	P/D 2263	H 905 (materasso mattress 1800x2000)
L/W 1755	P/D 2315	H 905 (materasso mattress QUEEN SIZE)
L/W 2095	P/D 2315	H 905 (materasso mattress KING SIZE)

Tebe

P 60

Design by gherardiarchitetti



- Letto sommier autoportante realizzato in pannelli di particelle disponibile in laccato opaco o impiallacciato in essenza. Caratterizzato da una cornice interna smussata a 45° disponibile in laccato opaco anche in contrasto.
- Testiera singola indipendente fornita di staffe per l'aggancio alla struttura del letto. Le testiere possono essere disposte liberamente sul perimetro del letto in quantità variabile. La testiera è sempre sfoderabile.
- Disponibile anche nella versione con contenitore.

- A free-standing bed made from particleboard, available in matt lacquer or wood veneered. It features a 45° bevelled inner frame available in matt lacquer, even in a contrasting finish.
- The single headboards are independent and supplied with brackets to attach them to the bed's structure. The headboards can be arranged around the perimeter of the bed in variable quantities. The headboard cover is always removable.
- Also available in the storage version.

TECHNICAL DRAWINGS

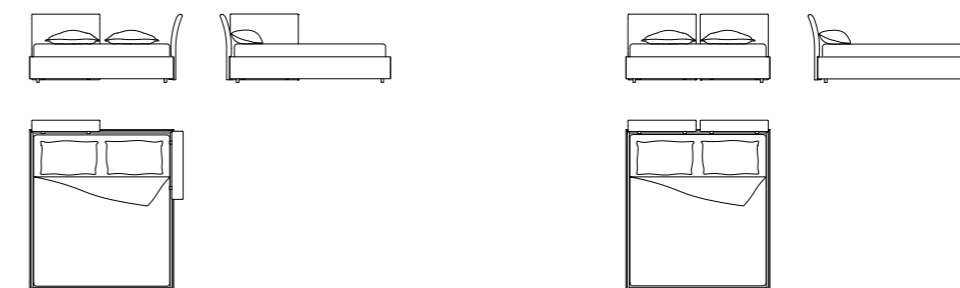

DIMENSIONI | SIZE

L/W 1303	P/D 2109	H 920 (materasso mattress 1200x2000)
L/W 1703	P/D 2109	H 920 (materasso mattress 1600x2000)
L/W 1903	P/D 2109	H 920 (materasso mattress 1800x2000)
L/W 1653	P/D 2159	H 920 (materasso mattress QUEEN SIZE)
L/W 2043	P/D 2159	H 920 (materasso mattress KING SIZE)

Niobe

P 68

Design by gherardiarchitetti



- Letto con struttura autoportante realizzata in pannelli di particelle, rivestita in tessuto, tecnopelle o pelle.
- La testiera è sfoderabile solo nella versione in tessuto; il giroletto è sempre sfoderabile.
- Letto fornibile in molteplici configurazioni con testiera simmetrica o asimmetrica rispetto al giroletto.
- Varianti: disponibile anche nella versione con rete e meccanismo contenitore a uno o due movimenti.

- Bed with a free-standing, particleboard structure upholstered in fabric, Tecnopelle or leather.
- Only fabric headboard covers are removable. The bed frame cover is always removable.
- The bed is available in many configurations with a headboard that can be symmetrical or asymmetrical with respect to the bed frame.
- Options: it is also available with a slatted base with storage featuring a two-position lift-up mechanism.

TECHNICAL DRAWINGS

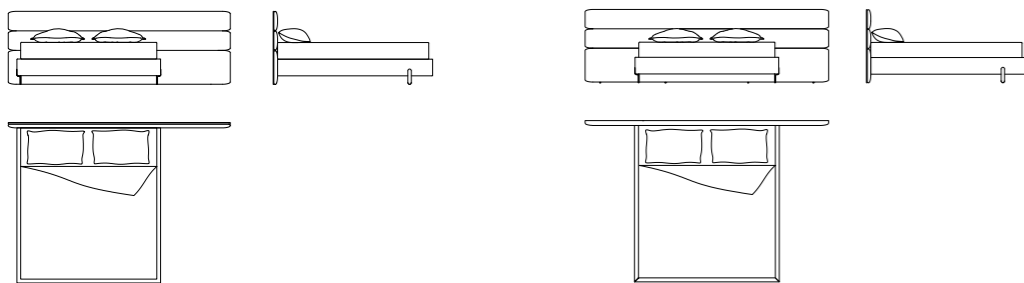

Per ulteriori disegni grafici consultare il listino.
For further graphic drawings refer to pricelist

DIMENSIONI | SIZE

L/W 1928/2736/3020	P/D 2160	H 906/970/1162 (materasso mattress 1600x2000)
L/W 2128/2936/3220	P/D 2160	H 906/970/1162 (materasso mattress 1800x2000)
L/W 1928/2736/3020	P/D 2210	H 906/970/1162 (materasso mattress QUEEN SIZE)
L/W 2268/3076/3360	P/D 2210	H 906/970/1162 (materasso mattress KING SIZE)

Delfi

P 76

Design by gherardiarchitetti



- Letto composto da una testiera a muro e da un ring autoportante.
- Le testiere, appese al muro, sono disponibili in due altezze: H. 450 e H. 950 mm.
- La testiera, realizzata in pannelli di particelle, è rivestita in tecnopelle o pelle, sempre sfoderabile.
- Testiera caratterizzata da due pomoli (con funzione decorativa), disponibili in finitura brunita o brass, e da sue asole in finitura con il rivestimento della testiera.
- Il ring può essere a scelta imbottito in tessuto, tecnopelle o pelle a cura del cliente.

- A bed made up of a wall-hung headboard and a free-standing bed frame.
- The wall-hung headboards are available in two heights: H. 450 and H. 950 mm.
- The particleboard headboard is upholstered with removable Tecnopelle or leather.
- The headboard features two, decorative knobs available with a burnished or brass finish and two eyeslets matching the finish of the headboard cover.
- The bed frame can be padded in fabric, Tecnopelle or leather as chosen by the customer.

TECHNICAL DRAWINGS

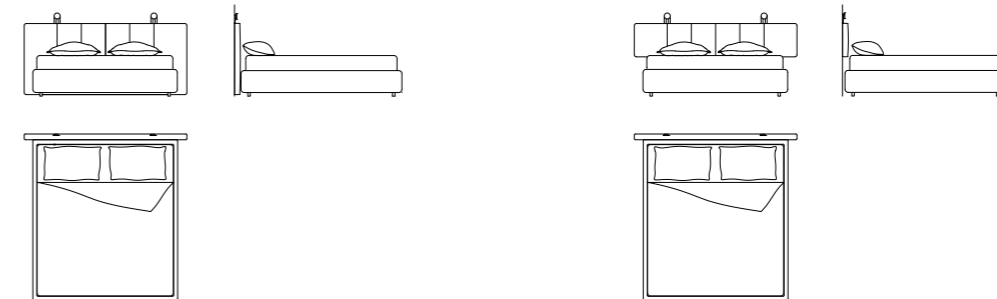

DIMENSIONI | SIZE

L/W 1900	P/D 2195	H 970 (materasso/mattress 1600x2000)
L/W 2150	P/D 2195	H 970 (materasso/mattress 1800x2000)
L/W 1900	P/D 2247	H 970 (materasso/mattress QUEEN SIZE)
L/W 2150	P/D 2247	H 970 (materasso/mattress KING SIZE)

Folio

P 84

Design by Pierangelo Sciuoto



- Letto composto da una testiera a muro componibile e da un ring autoportante.
- Le testiere, appese al muro, sono realizzate in pannelli di particelle e disponibili in svariate finiture : laccato opaco e lucido, color wood, essenza, ecomalta e ceramica. La versione imbottita è disponibile in tecnopelle o cuoio, non sfoderabile.
- La testiera è composta da pannelli boiserie accostati tra loro anche in finiture diverse e può essere integrata con mensole e comodini sospesi per permettere la realizzazione di soluzioni di estrema versatilità.
- Il ring può essere a scelta imbottito in tessuto, tecnopelle o pelle a cura del cliente.

- A bed made up of a modular, wall-hung headboard and a free-standing bed frame.
- The wall-hung headboards are made from particleboard panels and are available in various finishes: matt or gloss lacquer, Color Wood, wood veneer, Ecomalta and ceramic. The padded version is available in non-removable Tecnopelle or hide.
- The headboard is composed of wall panels installed side-by-side that are also available in different finishes. It can be integrated with shelves and night stands, making it possible to create a variety of arrangements.
- The bed frame can be padded in fabrics, leather or Tecnopelle, as chosen by the customer.

TECHNICAL DRAWINGS

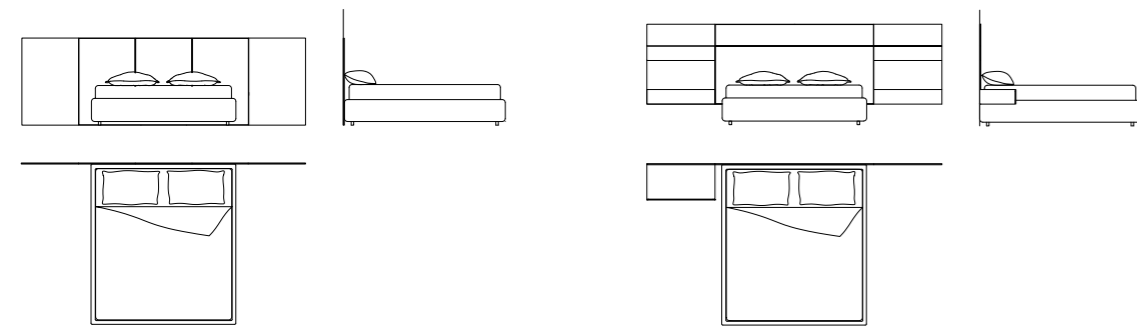

Per ulteriori disegni grafici consultare il listino.
For further graphic drawings refer to pricelist

DIMENSIONI | SIZE

L/W 600/750/900/1200/1350/1500/1800/2100/2400	P/D 50	H 192/288/384/576/768/864/960/1088/1152
L/W 1703	P/D 2129	H 334 (ring imbottito per materasso padded bed frame for mattress 1600x2000)
L/W 1903	P/D 2129	H 334 (ring imbottito per materasso padded bed frame for mattress 1800x2000)
L/W 1653	P/D 2181	H 334 (ring imbottito per materasso padded bed frame for mattress QUEEN SIZE)
L/W 2043	P/D 2181	H 334 (ring imbottito per materasso padded bed frame for mattress KING SIZE)

Plaid

P 92

Design by gherardiarchitetti



- Letto con struttura realizzata in pannelli di particelle, rivestita in tessuto o tecnopelle. Il rivestimento è sempre sfoderabile.
- La testiera si presenta suddivisa verticalmente in due porzioni ed è sempre retrofinita. È disponibile in due altezze per permettere l'accostamento ottimale anche di materassi con spessore rilevante. La testiera è sempre sfoderabile.
- Varianti: disponibile anche nella versione con rete e meccanismo contenitore a uno o due movimenti.

- Bed with a particleboard structure upholstered in fabric or Tecnopelle. The cover is always removable.
- The headboard is divided vertically into two parts and is always finished on the rear. It's available in two heights to accommodate particularly thick mattresses. The headboard cover is always removable.
- Options: it is also available with a slatted base with storage featuring a two-position lift-up mechanism.

TECHNICAL DRAWINGS

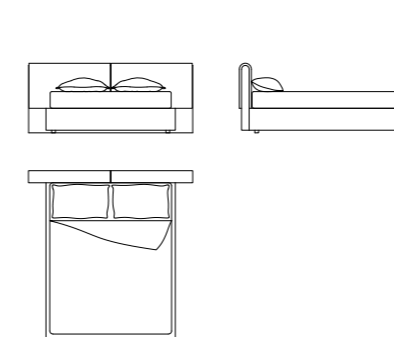

DIMENSIONI | SIZE

L/W 2170	P/D 2220	H 920/1120 (materasso mattress 1600x2000)
L/W 2370	P/D 2220	H 920/1120 (materasso mattress 1800x2000)
L/W 2170	P/D 2272	H 920/1120 (materasso mattress QUEEN SIZE)
L/W 2510	P/D 2272	H 920/1120 (materasso mattress KING SIZE)

Izy

P 100

Design by gherardiarchitetti



- Letto con struttura realizzata in pannelli di particelle, rivestita in tessuto e tecnopelle sempre sfoderabili.
- Caratterizzato da una testiera con pannello laterale orientabile disponibile su un lato o entrambi i lati. È inoltre disponibile anche senza pannelli laterali.
- La testiera, sempre retrofinita, si contraddistingue per una serie di cuciture verticali in tono con il rivestimento.
- Varianti: disponibile anche nella versione con rete e meccanismo contenitore a uno o due movimenti.

- Bed with a particleboard structure upholstered in removable fabric or Tecnopelle.
- It features a headboard with adjustable side panels available on one side or on both. It is also available without side panels.
- The headboard is always finished on the rear and stands out because of a set of vertical, stitched lines tone-on-tone with the cover.
- Options: It is also available with a slatted base with storage featuring a two-position lift-up mechanism.

TECHNICAL DRAWINGS

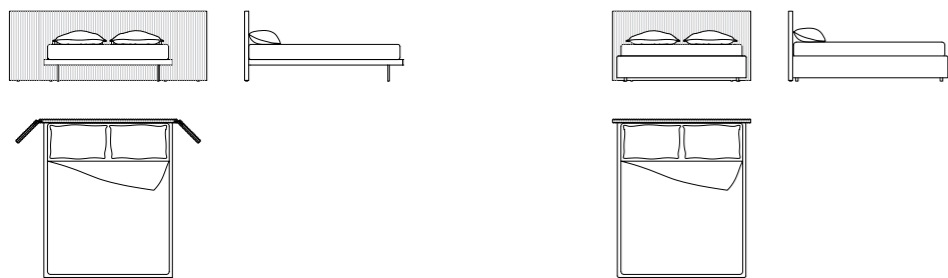

DIMENSIONI | SIZE

L/W 1827	P/D 2108/2145	H 926 (materasso mattress 1600x2000)
L/W 2027	P/D 2108/2145	H 926 (materasso mattress 1800x2000)
L/W 1827	P/D 2160/2197	H 926 (materasso mattress QUEEN SIZE)
L/W 2167	P/D 2160/2197	H 926 (materasso mattress KING SIZE)
L/W 391		H 926 (pannello laterale)

Wing

P 108

Design by Pierangelo Sciuto



- Letto con struttura realizzata in pannelli di particelle e massello di abete, rivestita in tessuto, tecnopelle o pelle.
- Le testiere, appese al muro, sono disponibili in due tipologie: Liscia rivestita in tessuto, tecnopelle o pelle (sfoderabile) e Capitonè rivestita in tecnopelle o pelle (non sfoderabile).
- Testiera disponibile in molteplici configurazioni simmetriche o asimmetriche.

- Bed with a structure made of particleboard and solid pinewood, upholstered in fabric, Tecnopelle or leather.
- Two types of wall-hung headboards are available: Liscia (plain) upholstered in removable fabric, Tecnopelle or leather and Capitonè (with deep-buttoned upholstery) upholstered in non-removable Tecnopelle or leather.
- The headboard is available in many symmetric and asymmetric configurations.

TECHNICAL DRAWINGS

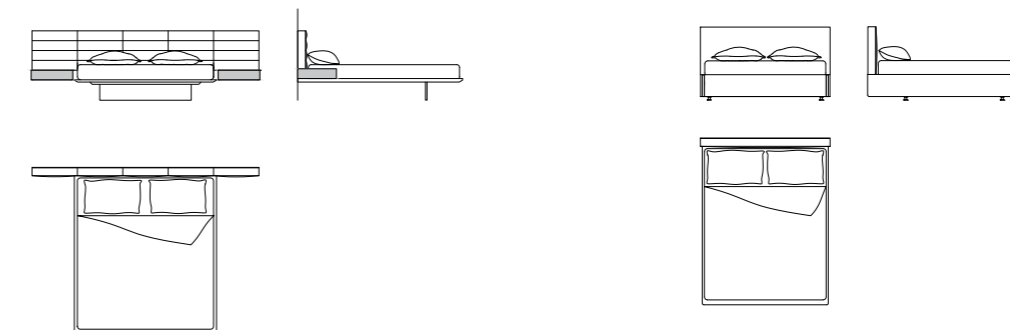

Per ulteriori disegni grafici consultare il listino.
For further graphic drawings refer to pricelist

DIMENSIONI | SIZE

L/W 1714/2218/2800/3384	P/D 2175/2205	H 917/964 (materasso mattress 1600x2000)
L/W 1914/2418/3000/3584	P/D 2175/2205	H 917/964 (materasso mattress 1800x2000)
L/W 1714/2218/2800/3384	P/D 2225/2255	H 917/964 (materasso mattress QUEEN SIZE)
L/W 2054/2558/3140/3724	P/D 2225/2255	H 917/964 (materasso mattress KING SIZE)

Meeting_up

P 116

Design by Presotto



- Letto con struttura realizzata in pannelli di particelle, rivestita in tessuto o tecnopelle. Il rivestimento è sfoderabile.
- Nella testiera e nel giroletto è caratterizzato da una combinazione di due rivestimenti che possono appartenere a categorie e colori diversi tra loro.

- Bed with a particleboard structure covered in fabric or Tecnopelle. The cover is removable.
- The headboard and the bed frame feature a combination of two covers in different colours and belonging to different categories.

TECHNICAL DRAWINGS

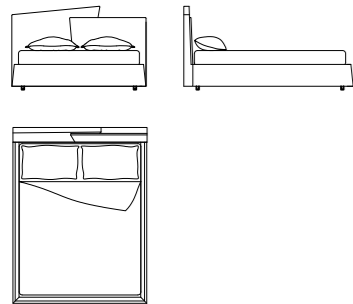

DIMENSIONI | SIZE

L/W 1774	P/D 2240	H 1100 (materasso mattress 1600x2000)
L/W 1974	P/D 2240	H 1100 (materasso mattress 1800x2000)
L/W 1774	P/D 2290	H 1100 (materasso mattress QUEEN SIZE)
L/W 2174	P/D 2290	H 1100 (materasso mattress KING SIZE)

Meeting

P 124

Design by Pierangelo Sciuoto



- Letto con struttura realizzata in pannelli di particelle, rivestita in tessuto, pelle o tecnopelle. Il rivestimento è sfoderabile.
- Nella testiera e nel giroletto è caratterizzato da una combinazione di due rivestimenti che possono appartenere a categorie e colori diversi tra loro.

- Bed with a particleboard structure upholstered in fabric, leather or Tecnopelle. The cover is removable.
- The headboard and the bed frame feature a combination of two covers in different colours and belonging to different categories.

TECHNICAL DRAWINGS

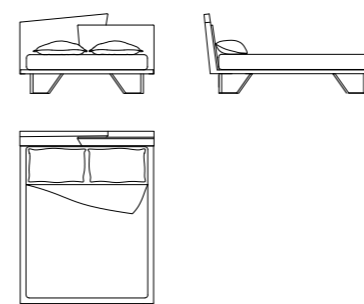

DIMENSIONI | SIZE

L/W 1774	P/D 2282	H 1054 (materasso mattress 1600x2000)
L/W 1974	P/D 2282	H 1054 (materasso mattress 1800x2000)
L/W 1774	P/D 2332	H 1054 (materasso mattress QUEEN SIZE)
L/W 2114	P/D 2332	H 1054 (materasso mattress KING SIZE)

Aqua

P 132

Design by Pierangelo Sciuto



- Struttura realizzata in multistrato curvato disponibile in laccato opaco, color wood o impiallacciato in essenza.
- Structure in curved plywood available in matt lacquer, Color Wood or wood veneered.

TECHNICAL DRAWINGS

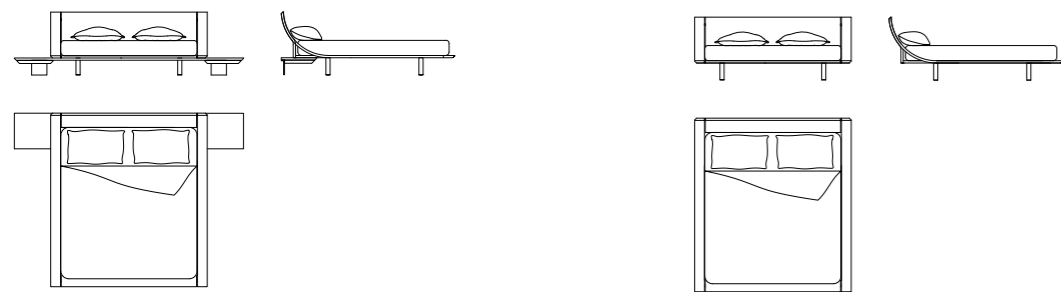

DIMENSIONI | SIZE

L/W 1870	P/D 2295	H 830 (materasso mattress 1600x2000)
L/W 2070	P/D 2295	H 830 (materasso mattress 1800x2000)
L/W 1820	P/D 2344	H 830 (materasso mattress QUEEN SIZE)
L/W 2210	P/D 2344	H 830 (materasso mattress KING SIZE)
L/W 530-630-730	P/D 470	(comodino sospeso)

Plana

P 140

Design by Claudio Lovadina



- Struttura realizzata in pannelli di particelle disponibile in laccato opaco.
- Structure made of particleboard available in matt lacquer.

TECHNICAL DRAWINGS

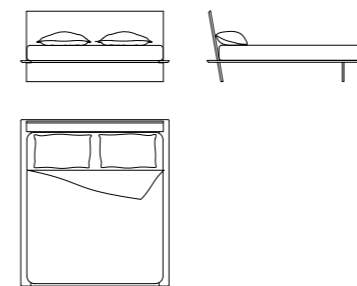

DIMENSIONI | SIZE

L/W 1760	P/D 2250	H 938 (materasso mattress 1600x2000)
L/W 1960	P/D 2250	H 938 (materasso mattress 1800x2000)
L/W 1760	P/D 2300	H 938 (materasso mattress QUEEN SIZE)
L/W 2100	P/D 2300	H 938 (materasso mattress KING SIZE)

Zero

P 148

Design by Pierangelo Sciuoto



- Letto con testiera realizzata in pannelli di particelle, rivestita in tecnopelle o pelle. Il rivestimento non e' sfoderabile.
- I ring sono realizzati in pannelli di particelle e massello di abete, imbottiti con tecnopelle o pelle. Il rivestimento e' sfoderabile.
- Il letto è disponibile in 2 taglie: Large, Medium.

- This bed features a particleboard headboard upholstered in Tecnopelle or leather. The cover cannot be removed.
- The bed frames are made from padded particleboard and solid pinewood with leather or Tecnopelle covers. The cover is removable.
- The bed is available in 2 sizes: Large and Medium.

TECHNICAL DRAWINGS

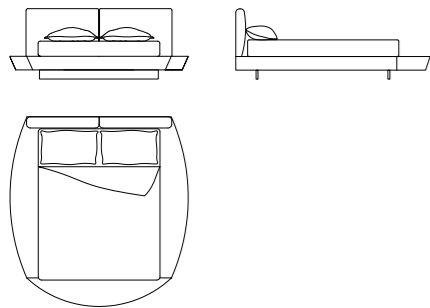

DIMENSIONI | SIZE

L/W 2364/2700	P/D 2507/2570	H 937 (materasso mattress 1600x2000)
L/W 2564/2900	P/D 2507/2570	H 937 (materasso mattress 1800x2000)
L/W 2364/2700	P/D 2557/2620	H 937 (materasso mattress QUEEN SIZE)

Peplo

P 156

Design by gherardiarchitetti



- Sistema componibile costituito da una struttura di pannelli Sp. 40 mm disponibile in melaminico, laccato opaco o impiallacciati in essenza e da una serie di attrezzature per rispondere a diverse funzionalità.
- Disponibile con cassettera in appoggio, pomoli appendiabiti, piano uso scrittoio, panca uso seduta con cuscino, tubo appendiabiti e specchiera laterale.
- Configurazioni possibili sia in versione monofacciale che bifacciale centrostanza a singola o doppia profondità.
- A modular system consisting of a structure made up of 40-mm thick panels available in melamine, matt lacquer or wood veneer and a set of accessories to meet various functions.
- Available with a drawer pack, round hangers, a desktop, a bench with a cushion, a hanging rail and a side mirror.
- Configurations are available in the single-faced or double-faced free-standing versions with one or two depths.

TECHNICAL DRAWINGS

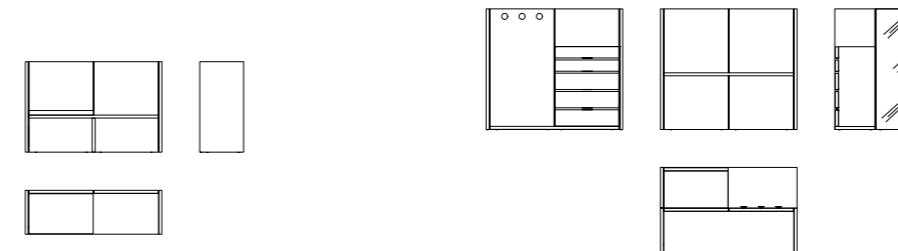

Per ulteriori disegni grafici consultare il listino.
For further graphic drawings refer to pricelist

DIMENSIONI | SIZE

L/W 658/850/1324/1516/1708/1990

P/D 580/1120

H 1200/1600

Complementi Notte

Night Furniture

Sigma

P 168

Design by gherardiarchitetti



- Gruppo notte con struttura realizzata in particelle di legno disponibile in laccato opaco o impiallacciata in essenza.
- Caratterizzato da una maniglia ad incasso disponibile in laccato opaco o metallico.
- Bedroom furniture with a wood particleboard structure available in matt lacquer or wood veneer.
- Featuring a recessed handle available in matt or metallic lacquer.

TECHNICAL DRAWINGS

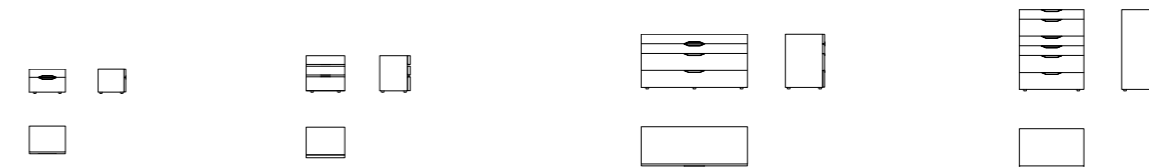

DIMENSIONI | SIZE

L/W 353/453/553/753	P/D 424	H 372 (comodino 2 cassetti / 2-drawer night stand)
L/W 353/453/553/753	P/D 424	H 500 (comodino 3 cassetti / 3-drawer night stand)
L/W 1405	P/D 520	H 723 (comò / dresser)
L/W 853	P/D 520	H 1074 (settimanale / narrow drawer chest)

Sibari

P 170

Design by gherardiarchitetti



- Gruppo notte con struttura realizzata in particelle di legno disponibile in laccato opaco, impiallacciata in essenza o microline wood.
- Caratterizzato da una cornice superiore in tinta o a contrasto che ospita un top personalizzabile in laccato opaco, essenza, vetro, ceramica, pelle o tecnopelle.
- Apertura con maniglia incassata nello spessore del frontale.

- Bedroom furniture with a wood particleboard structure available in matt lacquer, wood or microline wood veneer.
- Featuring a matching or contrasting- coloured upper frame that accommodates a top customisable in matt lacquer, wood, glass, ceramic, leather or Tecnopelle.
- Opens by means of a handle recessed into the top edge of the front.

TECHNICAL DRAWINGS

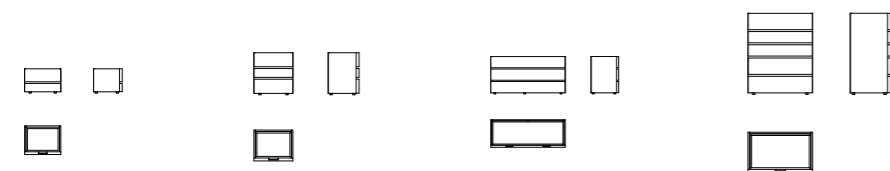

DIMENSIONI | SIZE

L/W 353/453/553/753	P/D 437	H 372 (comodino 2 cassetti / 2-drawer night stand)
L/W 353/453/553/753	P/D 437	H 596 (comodino 3 cassetti / 3-drawer night stand)
L/W 1439	P/D 533	H 772 (comò / dresser)
L/W 853	P/D 533	H 1073 (settimanale / narrow drawer chest)

Box

P 172

Design by Pierangelo Sciuto



- Gruppo notte con struttura realizzata in MDF Sp.10 con bordo frontale bisellato a 8 mm in laccato opaco.
- Frontali in particelle di legno in laccato opaco.
- Apertura con maniglia prensilità tra un frontale e l'altro.

- Bedroom furniture in matt lacquer featuring a 10-mm thick MDF structure with an 8-mm bevelled front edge.
- Matt lacquered wood particleboard fronts.
- Opens by means of a grip handle between the fronts.

TECHNICAL DRAWINGS

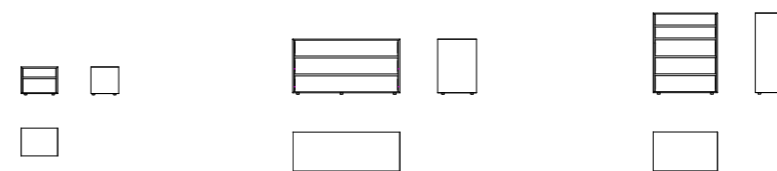

DIMENSIONI | SIZE

L/W 451/551	P/D 418	H 421 (comodino 2 cassetti / 2-drawer night stand)
L/W 1417	P/D 514	H 730 (comò / dresser)
L/W 851	P/D 514	H 1074 (settimanale / narrow drawer chest)

Club

P 174

Design by Pierangelo Sciuoto



- Gruppo notte con struttura e frontali Sp.40 mm realizzati in particelle di legno; disponibile in laccato opaco o impiallacciato in essenza.
- Apertura con maniglia incassata nello spessore del frontale.

- Bedroom furniture with 40-mm thick, wood particleboard structures and fronts, available matt lacquered or wood veneered.
- Opens by means of a handle recessed into the top edge of the front.

TECHNICAL DRAWINGS

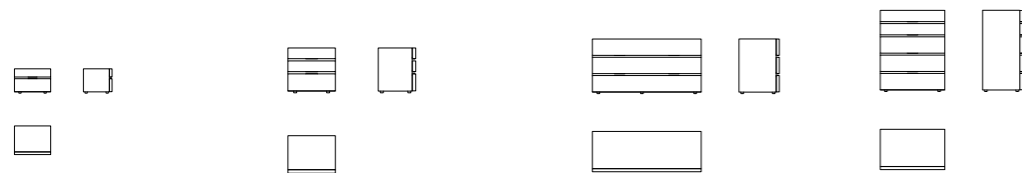

DIMENSIONI | SIZE

L/W 353/453/553/753	P/D 436	H 372 (comodino 2 cassetti / 2-drawer night stand)
L/W 353/453/553/753	P/D 436	H 523 (comodino 3 cassetti / 3-drawer night stand)
L/W 1439	P/D 532	H 723 (comò / dresser)
L/W 853	P/D 532	H 1074 (settimanale / narrow drawer chest)

Elle

P 176

Design by Pierangelo Sciuoto



- Gruppo notte con struttura e frontali realizzati in particelle di legno disponibile in laccato opaco, lucido, color wood o impiallacciato in essenza.
- Caratterizzato da una giunzione a 45° tra top e frontali di Sp. 40 mm che sporgono lateralmente rispetto al fianco.
- Apertura con prensilità laterale.

- Bedroom furniture with wood particleboard structures and fronts, available in matt or gloss lacquer, Color Wood or wood veneered.
- Distinguished by a 45° joint that connects the 40-mm thick tops and fronts which protrude beyond the side panel.
- They open by means of side grip grooves.

TECHNICAL DRAWINGS

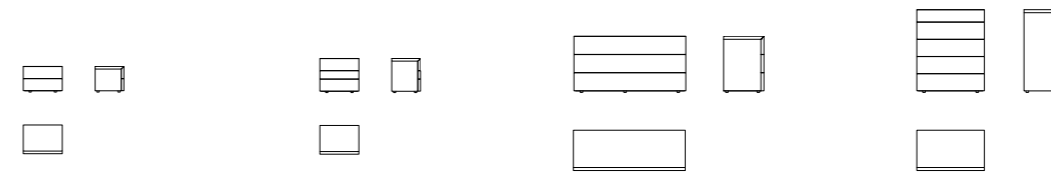

DIMENSIONI | SIZE

L/W 393/493/593/793	P/D 436	H 390 (comodino 2 cassetti / 2-drawer night stand)
L/W 393/493/593/793	P/D 436	H 519 (comodino 3 cassetti / 3-drawer night stand)
L/W 1245/1479	P/D 532	H 743 (comò / dresser)
L/W 893	P/D 532	H 1094 (settimanale / narrow drawer chest)

Globo

P 178

Design by Pierangelo Sciuoto



- Gruppo notte con struttura realizzata in particelle di legno disponibile in laccato opaco o lucido.
- Caratterizzato da frontali in multistrato curvato.
- Disponibile anche con top in marmo lucido o satinato.
- Apertura con maniglia incavata nel frontale.

- Bedroom furniture with a wood particleboard structure available in matt or gloss lacquer.
- Featuring curved plywood fronts.
- Also available with a polished or satin marble top.
- Opens by means of a handle carved out of the fronts.

TECHNICAL DRAWINGS

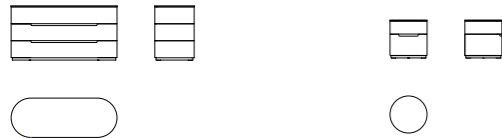

DIMENSIONI | SIZE

Ø495
L/W 1407 P/D 527 H 500/508 (comodino 2 cassetti / 2-drawer night stand)
H 717/725 (comò / dresser)

Ice

P 180

Design by Pierangelo Sciuoto



- Gruppo notte con struttura e frontali realizzati in particelle di legno disponibile in laccato opaco o lucido.
- Caratterizzato da una struttura stondata sui 4 lati formato da un pannello Sp.16 in laccato.
- Apertura con prensilità laterale.

- Bedroom furniture with wood particleboard structures and fronts available in matt or gloss lacquer.
- Featuring a structure made from a 16-mm thick lacquered panel rounded on 4 sides.
- It opens by means of side grip grooves.

TECHNICAL DRAWINGS



DIMENSIONI | SIZE

L/W 528 P/D 417 H 368 (comodino 2 cassetti / 2-drawer night stand)
L/W 1250 P/D 513 H 726 (comò / dresser)

Inside

P 182

Design by Pierangelo Sciuoto



- Gruppo notte con struttura realizzata in particelle di legno disponibile in laccato opaco.
- Frontali realizzati in MDF caratterizzati da un inserto verticale personalizzabile in laccato opaco, color wood, essenza, tecnopelle o pelle.
- Apertura con prensilità ad incasso sul frontale.

- Bedroom furniture with a wood particleboard structure available in matt lacquer.
- The fronts are made of MDF and feature a vertical insert that can be customised in matt lacquer, Color Wood, wood veneer, Tecnopelle or leather.
- They open by means of a recess in the front.

TECHNICAL DRAWINGS

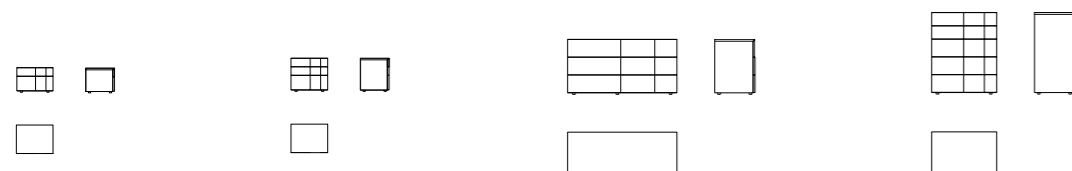

DIMENSIONI | SIZE

L/W 360/460/560/760	P/D 436	H 376 (comodino 2 cassetti / 2-drawer night stand)
L/W 360/460/560/760	P/D 436	H 507 (comodino 3 cassetti / 3-drawer night stand)
L/W 1446	P/D 532	H 728 (comò / dresser)
L/W 860	P/D 532	H 1079 (settimanale / narrow drawer chest)

Jazz

P 184

Design by Claudio Lovadina



- Gruppo notte con struttura realizzata in particelle di legno disponibile in laccato opaco.
- Frontali realizzati in MDF caratterizzati da un inserto diagonale realizzabile in laccato opaco o essenza.
- Apertura con prensilità ad incasso sul frontale.

- Bedroom furniture with a wood particleboard structure available in matt lacquer.
- The fronts are in MDF and feature a diagonal insert available in matt lacquer or wood veneer.
- They open by means of a recess in the front.

TECHNICAL DRAWINGS



DIMENSIONI | SIZE

L/W 560/760	P/D 436	H 376 (comodino 2 cassetti / 2-drawer night stand)
L/W 560/760	P/D 436	H 553 (comodino 3 cassetti / 3-drawer night stand)
L/W 1446	P/D 532	H 728 (comò / dresser)
L/W 860	P/D 532	H 1079 (settimanale / narrow drawer chest)

Memories

P 186

Design by Pierangelo Sciuoto



- Gruppo notte con struttura e frontali Sp. 20 mm realizzati in pannelli di particelle in finitura laccato opaco o impiallacciati in essenza.
- Bordo interno cassetto disponibile anche con finitura in contrasto laccato opaco o impiallacciata in essenza.
- Apertura con prensilità con gola.

- Bedroom furniture with a wood particleboard structure available in matt or gloss lacquer.
- Featuring curved plywood fronts.
- Also available with a polished or satin marble top.
- Opens by means of a handle carved out of the fronts.

TECHNICAL DRAWINGS

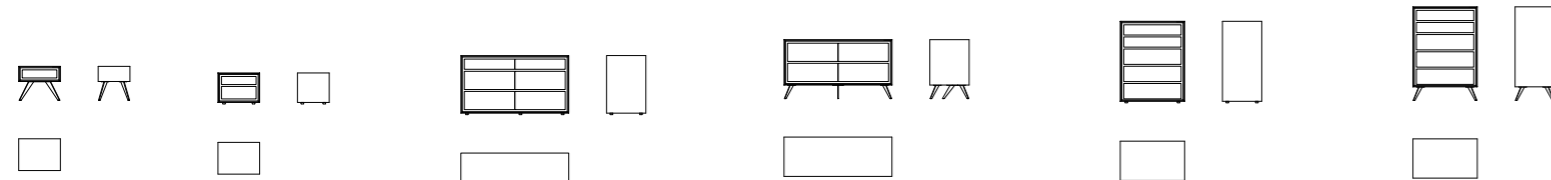

DIMENSIONI | SIZE

L/W 551	P/D 420	H 450 (comodino 1 cassetto / 1-drawer night stand)
L/W 551	P/D 420	H 410 (comodino 2 cassetti / 2-drawer night stand)
L/W 1427	P/D 520	H 780 (comò 4 cassetti con basamento / 4-drawer dresser with base)
L/W 1427	P/D 520	H 780 (comò 6 cassetti / (4-drawer dresser)
L/W 851	P/D 520	H 1078/1238 (settimanale / narrow drawer chest)

Passion

P 188

Design by Claudio Lovadina



- Gruppo notte con struttura e frontali realizzati in pannelli di particelle in finitura laccato opaco o lucido.
- Frontali realizzati in multistrato curvato e laccato.
- Struttura esterna realizzata da una lamiera curvata rivestita in pelle e tecnopelle.
- Apertura push-pull.

- Bedroom furniture with structures and fronts made from particleboard panels with a matt or gloss lacquered finish.
- Fronts made from curved and lacquered plywood.
- The outer structure consists of curved sheet metal covered with leather or Tecnopelle.
- Featuring the push-to-open mechanism

TECHNICAL DRAWINGS

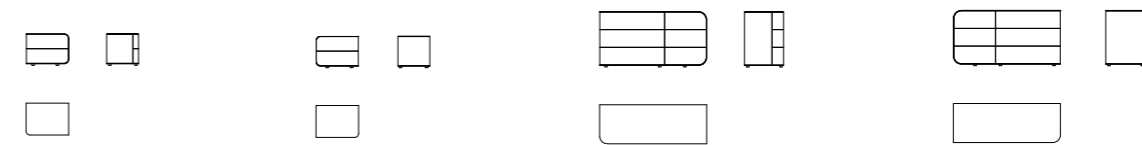

DIMENSIONI | SIZE

L/W 560	P/D 423	H 418 (comodino 2 cassetti / 2-drawer night stand)
L/W 1415	P/D 518	H 731 (comò / 6-drawer dresser)

I-night system

P 190

Design by Pierangelo Sciuoto



- Sistema componibile che attraverso l'accostamento di elementi diversi quali basi, comodini, comò e panche permette la realizzazione di soluzioni di estrema versatilità.
- Frontali Sp.6 mm con apertura push-pull e chiusura soft di serie.

- A modular system with which it is possible to create very versatile arrangements by putting together various elements such as base units, night stands, dressers and benches.
- 6-cm thick fronts with push-to-open and soft-close mechanisms are supplied as standard.

TECHNICAL DRAWINGS

Per ulteriori disegni grafici consultare il listino.
For further graphic drawings refer to pricelist

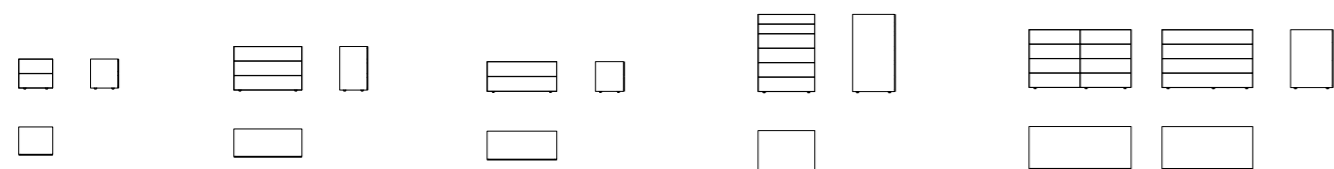

DIMENSIONI | SIZE

L/W 900/1200/1350/1500/1800/2100/2400	P/D 458/554	H 96 (panche/benches)
L/W 450/600/750/900/1200/1350/1500/1800/2100	P/D 373/469	H 192/384 (basi/base units)
L/W 450/600/750/900	P/D 373/469	H 129 (comodino 1 cassetto/ 1-drawer night stand)
L/W 1200/1350/1500/1800	P/D 373/469	H 129 (comodino 2 cassetti/ 2-drawer night stand)
L/W 450/600/750/900	P/D 373	H 384 (comodino 2 cassetti/ 2-drawer night stand)
L/W 450/600/750/900	P/D 373	H 576 (comodino 3 cassetti/ 3-drawer night stand)
L/W 1200	P/D 565	H 781 (comò 4 cassetti/ 4-drawer dresser)
L/W 1350	P/D 565	H 781 (comò 8 cassetti/ 8-drawer dresser)
L/W 750/900	P/D 565	H 1037 (comò 8 cassetti/ 8-drawer dresser)

I-night system_inclinART

P 192

Design by Pierangelo Sciuoto



- Sistema componibile con struttura inclinata a destra o sinistra che attraverso l'accostamento di elementi diversi quali basi, comodini, comò e panche permette la realizzazione di soluzioni di estrema versatilità.
- Frontali Sp. 6 mm con apertura push-pull e chiusura soft di serie.

- A modular system with a structure slanting to the left or right and with which it is possible to create very versatile arrangements by putting together various elements such as base units, night stands, dressers and benches.
- 6-cm thick fronts with push-to-open and soft-close mechanisms are supplied as standard.

TECHNICAL DRAWINGS

Per ulteriori disegni grafici consultare il listino.
For further graphic drawings refer to pricelist

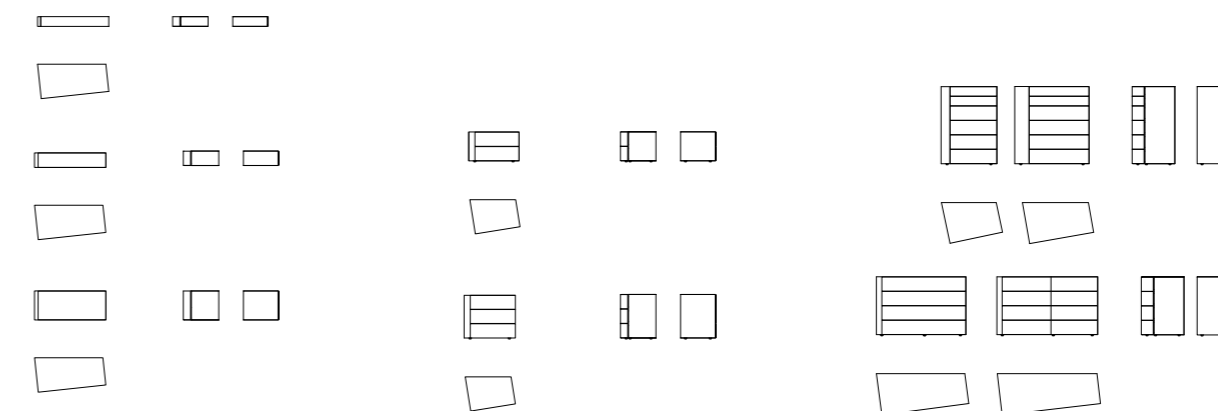

DIMENSIONI | SIZE

L/W 900/1200/1350/1500/1800/2100	H 96 (panche / bench)
L/W 450/600/750/900/1200/1350/1500/1800/2100	H 192/384 (basi / base units)
L/W 450/600/750/900	H 129 (comodino 1 cassetto / 1-drawer night stand)
L/W 1200/1350/1500/1800	H 129 (comodino 2 cassetti orizzontali / 2-drawer night stand)
L/W 450/600/750/900	H 384 (comodino 2 cassetti / 2-drawer night stand)
L/W 450/600/750/900	H 576 (comodino 3 cassetti / 3-drawer night stand)
L/W 1200	H 781 (comò 4 cassetti / 4-drawer dresser)
L/W 1350	H 781 (comò 8 cassetti / 8-drawer dresser)
L/W 750/900	H 1037 (comò 8 cassetti / 4-drawer dresser)

Onyx

P 194

Design by Pierangelo Sciuoto



- Gruppo notte con struttura realizzata in particelle di legno disponibile in laccato opaco, lucido o color wood.
- Apertura con maniglia applicata.

- Bedroom furniture with a wood particleboard structure available in matt or gloss lacquer or color wood.
- The fronts open by means of a handle.

TECHNICAL DRAWINGS

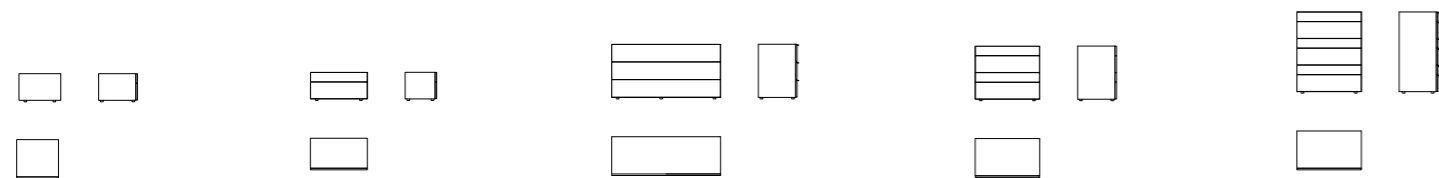

DIMENSIONI | SIZE

L/W 553	P/D 418	H 372 (comodino 1 cassetto / 1-drawer night stand)
L/W 353/453/553/753	P/D 418	H 372 (comodino 2 cassetti / 2-drawer night stand)
L/W 353/453/553/753	P/D 418	H 500 (comodino 3 cassetti/ 3-drawer night stand)
L/W 1205/1439	P/D 513	H 723 (comò / dresser)
L/W 853	P/D 513	H 1074 (settimanale / narrow drawer chest)

Wing

P 196

Design by Pierangelo Sciuoto



- Gruppo notte con struttura realizzata in particelle di legno disponibile in laccato opaco, lucido, color wood o essenza.
- I frontali, realizzati in MDF, possono essere caratterizzati da una finitura a contrasto in laccato opaco, lucido, color wood, impiallacciata in essenza o in pietra.
- Apertura con prensilità laterale.

- Bedroom furniture with a wood particleboard structure available in matt or gloss lacquer, Color Wood or wood veneer.
- The MDF fronts can have contrasting finishes in matt or gloss lacquer, Color Wood, wood veneer or stone.
- They open by means of side grip grooves.

TECHNICAL DRAWINGS

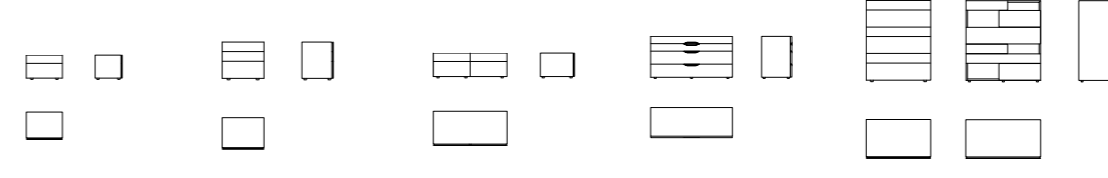

Per ulteriori disegni grafici consultare il listino.
For further graphic drawings refer to pricelist

DIMENSIONI | SIZE

L/W 553	P/D 438	H 129 (comodino 1 cassetto/ 1-drawer night stand)
L/W 1105	P/D 438	H 129 (comodino 2 cassetti orizzontali/ 2-drawer night stand)
L/W 353/453/553/753	P/D 417	H 372 (comodino 2 cassetti/ 2-drawer night stand)
L/W 353/453/553/753	P/D 417	H 500 (comodino 3 cassetti/ 3-drawer night stand)
L/W 853	P/D 512	H 372 (comò 2 cassetti/2-drawer dresser)
L/W 853	P/D 512	H 723 (comò 4 cassetti/4-drawer dresser)
L/W 1105/1405	P/D 512	H 723 (comò 8 cassetti/8-drawer dresser)
L/W 853	P/D 512	H 1074 (settimanale/ narrow drawer chest)
L/W 987	P/D 512	H 1074 (settimanale con vani a giorno/ narrow drawer chest with cubby holes)

Relevé

scrivania / desk

P 200

Design by gherardiarchitetti



- Struttura realizzata in legno naturale impiallacciato in essenza con piano incassato a filo nella struttura disponibile in vetro, ceramica, rivestito in pelle o impiallacciato in essenza.
- È possibile affiancare allo scrivania un comodino uso cassetiera per aumentarne la funzionalità. Svariate misure disponibili.
- La superficie interna delle gambe può essere laccata opaca.

- Wood veneered, natural timber frame with a top fitted flush with the frame available in lacquered glass, ceramic, covered with leather or veneer.
- To make the desk even more functional, a nightstand used as a drawer unit can be added to it. Many sizes available.
- The inner surface of the legs can be matt lacquered.

TECHNICAL DRAWINGS



DIMENSIONI | SIZE

L/W 1250

P/D 590

H 750

Swing console

P 202

Design by Pierangelo Sciuoto



- Console scrittoio con struttura in particelle di legno e frontali in MDF disponibile in laccato opaco, lucido, color wood o impiallacciata in essenza.
- I cassetti sono dotati di chiusura soft di serie e possono avere un rivestimento interno al cassetto in vellutino colore nero.
- Basamento metallico laccato opaco.

- Modular console desk with a wood particleboard frame and MDF fronts available in matt or gloss lacquer, Color Wood or wood veneered.
- The drawers are supplied soft-close as standard and can be lined with black velveteen.
- Matt lacquered metal base.

TECHNICAL DRAWINGS

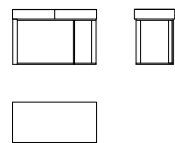

DIMENSIONI | SIZE

L/W 1112 P/D 534 H 726

Swing

P 204

Design by Pierangelo Sciuoto



- Console scrittoio componibile con struttura in particelle di legno e frontali in MDF disponibile in laccato opaco, lucido, color wood o impiallacciata in essenza.
- I cassetti sono dotati di chiusura soft di serie e possono essere caratterizzati da una finitura a contrasto in laccato opaco, lucido, color wood impiallacciata in essenza o in pietra.

- Modular console desk with a wood particleboard frame and MDF fronts available in matt or gloss lacquer, Color Wood or wood veneered.
- The drawers are supplied soft-close as standard and are also available with a contrasting finish in matt or gloss lacquer, Color Wood, wood veneer or stone.

TECHNICAL DRAWINGS



Per ulteriori disegni grafici consultare il listino.
For further graphic drawings refer to pricelist

DIMENSIONI | SIZE

L/W 1105/1657 P/D 512 H 129 (elemento orizzontale / horizontal element)
L/W 553 P/D 417 H 575 (elemento verticale) / vertical element)

I-night system

P 206

Design by Pierangelo Sciuto

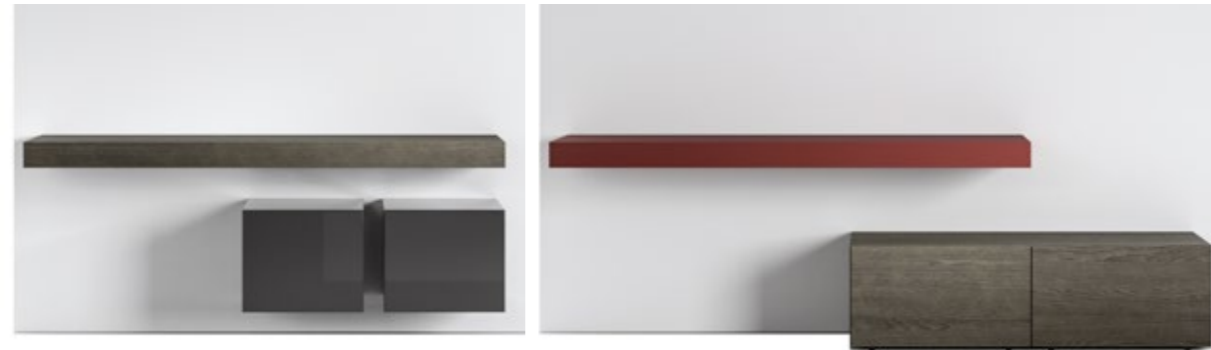

- Sistema componibile che attraverso l'accostamento di elementi diversi quali basi, comodini e panche permette la realizzazione di console scrittoio di estrema versatilità.
- Frontali Sp.6 mm con apertura push-pull e chiusura soft di serie.

- A modular system with which it is possible to create very versatile console desks by putting together various elements such as base units, night stands and benches.
- 6-cm thick fronts with push-to-open and soft-close mechanisms are supplied as standard.

TECHNICAL DRAWINGS

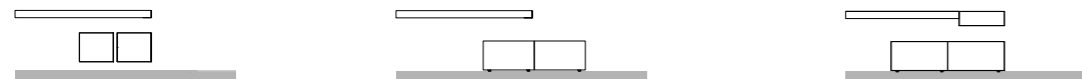

Per ulteriori disegni grafici consultare il listino.
For further graphic drawings refer to pricelist

DIMENSIONI | SIZE

L/W 900/1200/1350/1500/1800/2100/2400	P/D 458/554	H 96 (panche / benches)
L/W 450/600/750/900/1200/1350/1500/1800/2100	P/D 373/469	H 192/384 (basi / base units)
L/W 450/600/750/900	P/D 373/469	H 129 (comodino 1 cassetto / 1-drawer night stand)
L/W 1200/1350/1500/1800	P/D 373/469	H 129 (comodino 2 cassetti orizzontali / 2-drawer night stand)
L/W 450/600/750/900	P/D 373	H 384 (comodino 2 cassetti / 2-drawer night stand)
L/W 450/600/750/900	P/D 373	H 576 (comodino 3 cassetti / 3-drawer night stand)
L/W 1200	P/D 565	H 781 (comò 4 cassetti / 4-drawer dresser)
L/W 1350	P/D 565	H 781 (comò 8 cassetti / 8-drawer dresser)
L/W 750/900	P/D 565	H 1037 (comò 8 cassetti / 8-drawer dresser)

I-night system_inclinART

P 208

Design by Pierangelo Sciuto

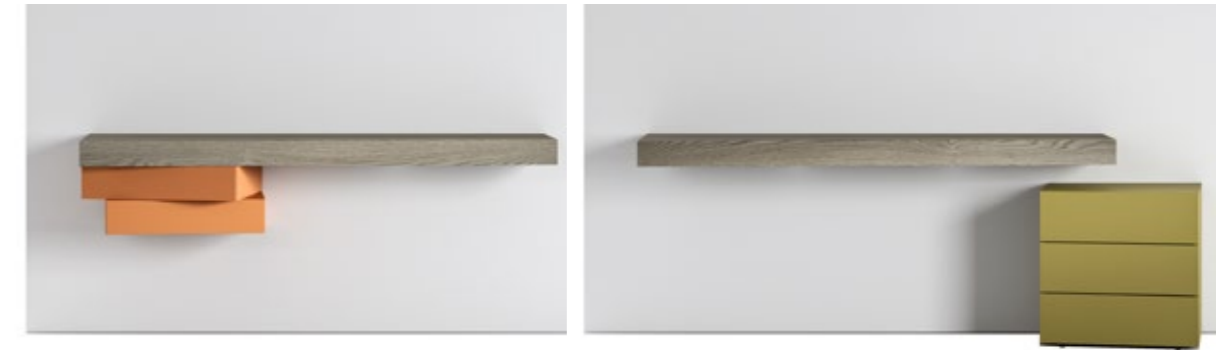

- Sistema componibile con struttura inclinata a destra o sinistra che attraverso l'accostamento di elementi diversi quali basi, comodini e panche permette la realizzazione di console scrittoio di estrema versatilità.
- Frontali Sp.6 mm con apertura push-pull e chiusura soft di serie.

- A modular system with a structure slanting to the left or right and with which it is possible to create very versatile console desks by putting together various elements such as base units, night stands and benches.
- 6-cm thick fronts with push-to-open and soft-close mechanisms are supplied as standard.

TECHNICAL DRAWINGS



Per ulteriori disegni grafici consultare il listino.
For further graphic drawings refer to pricelist

DIMENSIONI | SIZE

L/W 900/1200/1350/1500/1800/2100	H 96 (panche / benches)
L/W 450/600/750/900/1200/1350/1500/1800/2100	H 192/384 (basi / base units)
L/W 450/600/750/900	H 129 (comodino 1 cassetto / 1-drawer night stand)
L/W 1200/1350/1500/1800	H 129 (comodino 2 cassetti orizzontali / night stand with 2 horizontal drawers)
L/W 450/600/750/900	H 384 (comodino 2 cassetti / 2-drawer night stand)
L/W 450/600/750/900	H 576 (comodino 3 cassetti / 3-drawer night stand)
L/W 1200	H 781 (comò 4 cassetti / 4-drawer dresser)
L/W 1350	H 781 (comò 8 cassetti / 8-drawer dresser)
L/W 750/900	H 1037 (comò 8 cassetti / 8-drawer dresser)

Console scrittoio

P 210

Design by Presotto



- Console scrittoio con struttura Sp. 50 mm in particelle di legno disponibile in laccato opaco, lucido, color wood o impiallacciato in essenza.
- Può essere montata in appoggio ai comò Box, Club_2, Elle, Ice, I-night system, Inside, Onyx, Wing e Sigma; il suo posizionamento in larghezza è libero.
- Console desk with a 50-mm thick wood particleboard frame available in matt or gloss lacquer, Color Wood or wood veneered.
- It can be installed on top of Box, Club_2, Elle, Ice, I-night system, Inside, Onyx, Wing and Sigma dressers and positioned at will width-wise.

TECHNICAL DRAWINGS

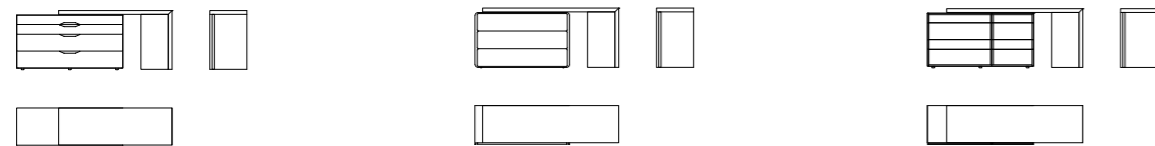

Per ulteriori disegni grafici consultare il listino.
For further graphic drawings refer to pricelist

DIMENSIONI | SIZE

L/W 1200/1500/1800 P/D 490 H 783-841

Altezza variabile a seconda del comò / Its height varies depending on the dresser.

Relevé

panca / bench

P 212

Design by gherardiarchitetti



- Struttura realizzata in legno naturale impiallacciato in essenza con piano incassato a filo nella struttura disponibile in vetro, ceramica, rivestito in pelle o impiallacciato in essenza.
- La superficie interna delle gambe può essere laccata opaca.
- Wood veneered, natural timber frame with a top fitted flush with the frame available in lacquered glass, ceramic, covered with leather or veneered.
- The inner surface of the legs can be matt lacquered.

TECHNICAL DRAWINGS



DIMENSIONI | SIZE

L/W 982 P/D 454 H 334
L/W 1768 P/D 454 H 334

Diadro

panca / bench

P 214

Design by gherardiarchitetti



- Panca con struttura realizzata in metallo verniciato. Le due gambe sono connesse da un tirante di rinforzo nella medesima finitura.
- Piano realizzato con un pannello di tamburato di spessore 50 mm, interamente impiallacciato in essenza.

- A bench with a lacquered metal structure. The two legs are connected by a strengthening crossbar in the same finish.
- The top is made of a 50-mm thick honeycomb panel wood veneered all over.

TECHNICAL DRAWINGS



DIMENSIONI | SIZE

L/W 1600/2000 P/D 550 H 505

Cali

panca / bench

P 216

Design by gherardiarchitetti



- Panca con struttura realizzata in pannelli di particelle, rivestita in tecnopelle o pelle non sfoderabile.
- Caratterizzato da un cuscino espanso e falda accoppiata rivestito in tessuto, pelle o tecnopelle. Il cuscino e' sempre sfoderabile.
- Basamento costituito da piedi metallici di sezione circolare in finitura laccata metallica.

- Bench with a particleboard panel structure upholstered in non-removable Tecnopelle or leather.
- Features a cushion made of foam and bonded wadding upholstered in fabric, leather or Tecnopelle. The cushion cover is always removable.
- The base consists of metallic lacquered, cylindrical metal feet.

TECHNICAL DRAWINGS

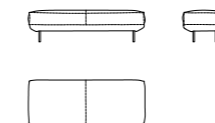

DIMENSIONI | SIZE

L/W 1500 P/D 500 H 415

Point

P 218

Design by Pierangelo Sciuoto



- Struttura costituita da un basamento in metallo verniciato.
- Piano circolare smussato inferiormente in finitura laccata opaca o lucida, disponibile con cassetto girevole con verso di apertura destro o sinistro.
- The frame consists of a lacquered metal base.
- Rounded bevelled circular top in matt or gloss lacquered finish, available with a swivel drawer opening to the left or right.

TECHNICAL DRAWINGS



DIMENSIONI | SIZE

Ø504 H 440

Pilar

P 220

Design by Presotto



- I pouf sono realizzati in pannelli di particelle imbottiti non sfoderabili in tessuto, tecnopelle o pelle.
- Nei pouf rivestiti con tessuti in fantasia, il disegno potrebbe non seguire la centratura.
- Disponibile con vassoio d'appoggio optional in laccato opaco o impiallacciato in essenza.
- Poufs are made from particleboard upholstered with non-removable fabric, Tecnopelle or leather covers.
- For poufs upholstered in patterned fabrics, the pattern may not always be centred.
- Available with an optional matt lacquered or wood veneered tray top.

TECHNICAL DRAWINGS

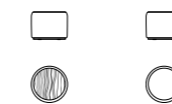

DIMENSIONI | SIZE

Ø 490 H 380

Pouf quadrato

P 222

Design by gherardiarchitetti



- I pouf sono realizzati in pannelli di particelle imbottiti sfoderabili in tessuto, tecnopelle o pelle.
- Nei pouf rivestiti con tessuti fantasie, il disegno potrebbe non seguire la centratura.
- Our poufs are made from padded particleboard covered with removable fabric, Tecnopelle or leather.
- For poufs covered with patterned fabrics, the pattern may not always be centred.

TECHNICAL DRAWINGS

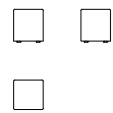

DIMENSIONI | SIZE

L/W 390 P/D 390 H 435

Mimesi

P 224

Design by gherardiarchitetti

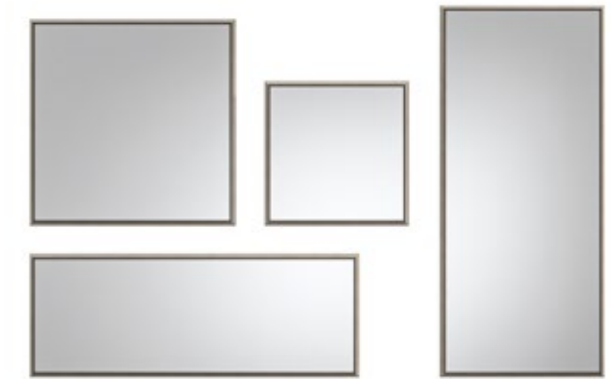

- Specchiera a parete caratterizzata da una cornice smussata in legno verniciato.
- Wall mirror featuring a lacquered wood, bevelled frame.

TECHNICAL DRAWINGS



DIMENSIONI | SIZE

L/W 700	P/D 58	H 700
L/W 1000	P/D 58	H 1000
L/W 1600	P/D 58	H 600
L/W 800	P/D 58	H 1800

Tuttospecchio

P 226

Design by Pierangelo Sciuoto



- Struttura in pannello tamburato formato da telaio in pannelli di particelle rivestito con specchi giuntati a 45°, piedini in metallo cromato.
- The structure consists in a honeycomb core panel made up of a wood particleboard frame covered with mirrors joined at 45°. Chromed metal feet.

TECHNICAL DRAWINGS

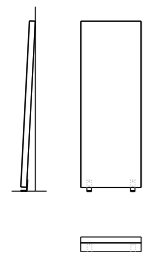

DIMENSIONI | SIZE

L/W 800

P/D 80/195

H 2200

Finiture

Finishes

FINITURE | Laccato opaco 28 colori
Matt lacquers



Bianco candido Bianco latte Nero frac

WHITE AND BLACK



Beige gipso Beige seta Beige cappuccino Beige fango Beige argilla Marrone corteccia

NEUTRALS



Grigio calce Grigio polvere Grigio nebbia Grigio tasmania Grigio Londra Grigio antracite



Giallo bambù Arancio cotto Rosa pompelmo Rosa litchi Rosso vermut Rosso rubino

COLOURS



Verde spiga Verde salvia Verde timo Verde edera Blu lavanda Blu vinca Blu abisso

FINITURE | Laccato lucido 16 colori
Glossy lacquers

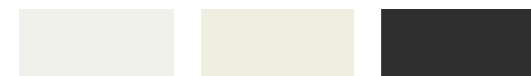

Bianco candido Bianco latte Nero frac

WHITE AND BLACK



Beige seta Beige cappuccino Marrone corteccia

NEUTRALS



Grigio polvere Grigio nebbia Grigio antracite



Giallo bambù Rosa litchi Rosso rubino

COLOURS



Verde timo Verde edera Blu vinca Blu lavanda Blu abisso

FINITURE | Color wood 15 colori



Bianco candido Bianco latte Nero frac

WHITE AND BLACK



Beige gipso Beige seta Beige cappuccino Beige fango Beige argilla Marrone corteccia

NEUTRALS



Grigio calce Grigio polvere Grigio nebbia Grigio tasmania Grigio Londra Grigio antracite

FINITURE | Essenze 6 colori
Wood



Castagno naturale Rovere avana Rovere lince Noce canaletto Rovere tabacco Rovere dark

FINITURE | Melaminico 4 colori
Wood



Lino Rovere Argilla Eucalipto Tay

FINITURE | Vetro colorato lucido e opaco 15 colori
Matt and glossy lacquered glass



Bianco candido Bianco latte Nero frac

WHITE AND BLACK



Beige gipso Beige seta Beige cappuccino Beige fango Beige argilla Marrone corteccia

NEUTRALS



Grigio calce Grigio polvere Grigio nebbia Grigio tasmania Grigio Londra Grigio antracite

FINITURE | Vetri speciali
Glass



Specchio Specchio bronzo Specchio grigio

CLEAR GLASS

FINITURE | Materie

STONE



Silver shine Cooper Galaxy

PATCHWORK STONE



Silver shine Cooper Galaxy



Bianca Grigio polvere Beige seta Beige argilla Grigio Londra

ECOMALTA

METALLIC LACQUER



Iron Bronze Brass Brunito

METAL

CERAMIC 8 COLORS

CERAMIC | BRUSHED FINISH

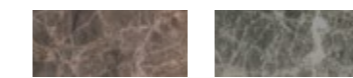

Emperador marrone Emperador grigio

CERAMIC | MATT FINISH



Grigio fiume Nero marquinia

CERAMIC | GLOSSY FINISH



Calacatta Pulpis brown Grey marble Porte d'or

MARBLE



Carrara Nero marquinia Grigio carnico

Note

Notes

Credits

Project

gherardiarchitetti

Images

Nerokubo

Styling

gherardiarchitetti

Printing

Grafiche GFP, Maggio 2020

Contacts

PRESOTTO INDUSTRIE MOBILI S.p.a.

via Puja, 7 frazione Maron

33070 Brugnera (PN) italy

t +39 0434 618111

f +39 0434 618212

www.presotto.com

Thanks to

101 Copenhagen
Amini carpets
Aromas del Campo
Azucena
Bitossi
Blu dot
Boku Morandi
Castellani & Smith
CB2
CC-tapis
Danese
David Pompa
Davide Groppi
DCW édition
DELTA light
E15
Flos
FontanaArte
Foscarini
GAN
GT design
Kahndall
Kartell
Kristina Dam Studio
Lambert & Fils
Lee Broom
Leucos
Linea light
Louis Poulsen
Luceplan
Lyngby porcelain
MANI
Martinelli luce
Menu
Michael Anastassiades
Milia Seyppel

Nahoor
Nason Moretti
NEMO lighting
Noom
Normann Copenhagen
Northern
Oluce
Pentalight
Philip Finner ceramics
Salice
Salvatori
Sartori
Seletti
Serge Mouille
SIRECOM
Sonneman
Studio Henry Wilson
VeniceM
Vibia
Vitra
Waypoint light
Zara home

Copyright © 2020 Presotto

Tutti i diritti sono riservati.
É vietata la riproduzione sotto forma di stampa, fotocopia, microfilm, o qualsiasi altro sistema, senza il permesso scritto della società autrice.

L'azienda si riserva di apportare modifiche al prodotto in qualsiasi momento senza alcun preavviso al fine di migliorare la qualità.

All rights reserved.
No part of this catalogue may be reproduced in any form by print, photocopy, microfilm, recording or other means without the prior written permission of the publishers.

The company is entitled to modify its products to the aim of improving their quality at any time without giving prior notice.